



RABIES

Control and Bite



ADPH

Alabama Department of Public Health

Division of Epidemiology • Zoonotic Disease Branch

About the Cover

The picture on the cover is an artist's rendition of St. Hubert, the patron saint of rabies victims. As rabies posed a deadly threat in medieval Europe, peasants that needed help turned to St. Hubert. His shrine near Liege, Belgium, drew hundreds of the faithful to pray for those suffering from this dangerous and deadly disease.

St. Hubert used iron bars or crosses that were heated red-hot and applied to wounds of medieval European peasants. Since it was thought that this was a miracle cure, and to some extent it was an effective treatment, some individuals would wear the keys as amulets or place the keys into the walls of houses to protect all believers from rabies.

The keys were irons, heated red hot, and applied to wounds left by rabid animals. Although agonizingly painful, this method actually helped on occasion by providing a primitive technique of sterilization, to reduce the rabies virus load at the bite sites. Even today, cleansing of a bite wound is the first step in any post-exposure treatment regimen for rabies.

Because not all villagers were fortunate enough to make a trip to his shrine in distant Belgium, many utilized iron bars or crosses known as the "keys" of St. Hubert as jewelry or displays in their dwellings. These "cures" were seen as miracles by the peasants. As time progressed, scholars denounced the keys of St. Hubert, but belief among the peasantry remained up until the late nineteenth century.

Contents

Introduction	4
Rabies Overview	5
Biology, Transmission, and Pathogenesis	6
Incubation Period and Duration of Disease	10
Control Methods in Humans	11
Assessing the Need for PEP	13
Rabies Post-Exposure Vaccination for Humans	16
Ordering Human Rabies Vaccine	18
Rabies Pre-Exposure Vaccination for Humans	21
Possible Adverse Reactions Associated with Rabies Biologics	22
Animal Vaccination Protocols	25
Management of Animals Exposed to Rabies	26
Management of Animals that Bite Humans	29
Rabies Testing	31
Tissue Sample Collection and Handling for Rabies Testing	32
Rabies Specimen Acceptance Criteria	33
Rabies Serology Testing for Humans	35
Importation and Interstate Movement of Animals	37
Rabies Control during a Disaster Response	38
Frequently Asked Questions (FAQ) About Rabies	39
Forms	43
Animal-Related Injury or Damage Contacts	45
Current FDA Licensed Rabies Vaccines	47
Alabama Positive Rabies Cases (55 year period)	48
Alabama Positive Rabies Cases (Graph)	50
Code of Alabama, 1975	51
ADPH Administrative Code (Chap. 420-4-4 Rabies Control Program--Rules)	65
Certificate of Exemption From Rabies Vaccination Form	71

Introduction

This manual is intended to provide current information on rabies biology, transmission, pathogenesis, and prevention in humans and animals. It also focuses on rabies control and bite management by outlining treatment protocols for humans and animals that have been potentially exposed to the rabies virus. The manual should serve as a guide for physicians and other healthcare providers to determine rabies exposures, recommended pre- and post-exposure rabies prophylaxis, viral shedding, and information on human rabies vaccines.

Veterinarians, animal control personnel and law enforcement agencies should find the manual useful for guidance on management of domestic animals that have been exposed to wildlife or other potentially rabid animals, proper quarantine protocols, and proper vaccination requirements. Altogether, this manual should serve as an educational tool to prevent and control rabies.

This manual is based primarily on a compilation of recommendations based mostly from the following:

1. Human Rabies Prevention – United States, 2008, Recommendations of the Advisory Committee on Immunization Practices (<http://www.cdc.gov/mmwr/pdf/rr/rr57e507.pdf>)
2. 2008 NASPHV Compendium of Animal Rabies Prevention and Control (<http://www.cdc.gov/mmwr/pdf/rr/rr5702.pdf>)
3. CDC Rabies Page (<http://www.cdc.gov/rabies>)
4. Alabama Statutes and Legislative Code
5. *Red Book: 2006 Report of the Committee on Infectious Diseases*. 27th Edition, American Academy of Pediatrics.
6. The helpful guidance of experts in the field of rabies research and veterinary medicine.
7. Information from similar manuals prepared by the states of Georgia, New York, Virginia, California, Maine, New Jersey, Texas, Connecticut, and Massachusetts, and their contributions are gratefully acknowledged.

Rabies Overview

Rabies is a viral infection transmitted in the saliva of infected mammals. The virus enters the central nervous system of the host with resulting inflammation that is almost always fatal. Rabies is currently present in all states, except for Hawaii. Although all mammals are susceptible to rabies virus infection, only a few species are reservoirs for the disease in nature. In the United States, several distinct rabies virus variants have been identified in populations of raccoons, skunks, foxes, and coyotes. In addition to the terrestrial reservoirs for rabies, several species of insectivorous bats also serve as reservoirs for the disease. Raccoons and bats are the major reservoirs for wildlife rabies in Alabama. Foxes and other wild carnivores can be infected by raccoons and often test positive with the raccoon variant of the rabies virus.

The epidemiology of the positive rabies cases in Alabama has changed drastically over the past 60 years. In 1948, dogs and cats comprised 70% of the 358 positive rabies tests. In the 1960s, due to the public health programs initiating mandatory animal vaccinations, there was a dramatic decrease in rabies in dogs and cats. However, another dynamic of positive rabies cases was beginning to surface in the mid-1970s. During this period, the number of skunks and raccoons that tested positive for rabies sharply increased. Although skunk positives have waned significantly in recent decades, raccoons remain as the most common wild terrestrial animal with rabies in Alabama. The raccoon variant of the rabies virus is believed to have originated in Florida and has steadily spread northward and eastward through natural movement and illegal translocation of raccoons incubating the rabies virus. Currently, the southeastern part of the state is endemic with the raccoon variant of rabies. The region generally to the south and east of the Alabama and Coosa River system accounts for the vast majority of positive animal tests. However, sporadic positive may be found outside of the endemic area.

For most Alabamians, the most common connection to rabid animals is through their pets. Reducing the risk of rabies in domestic animals is central to the prevention of human rabies. Vaccinating and removing stray animals that are at risk of exposure to rabid wildlife is the basic element of a rabies control program. Alabama law (Code of Alabama 1975 §3-7A-2) requires that all owned dogs, cats, and ferrets be vaccinated against rabies by a licensed veterinarian with an approved vaccine.

Nationally, indigenously acquired rabies among humans has declined markedly in recent years. In the last century the average number of human rabies cases has dropped from around a hundred per year to 2 or 3 cases per year. This reduction further signifies the importance of advances made in human rabies vaccine and rabies control programs.

The most recent case of human rabies in Alabama was in 1994, as a result of the bat variant. All human cases in the United States since 1990 known to have contracted rabies while stateside have been from a bat variant. Human rabies cases from other variants since 1990 were acquired while traveling abroad. Whether this is due to increased human exposure to bats or to an increase in the percentage bats harboring rabies is debatable. Bites from bats are also particularly concerning because of their difficulty to recognize which may result in an unknown exposure.

Since rabies is a statistically 100% fatal disease, the focus is to prevent human rabies by administering rabies post-exposure prophylaxis if exposure occurs. Additional efforts should be made to prevent additional human exposure through rabies education, animal quarantine and animal vaccination.

Biology, Transmission, and Pathogenesis

Rabies Virus

The rabies virus belongs to the order Mononegavirales, viruses with a nonsegmented, negative-stranded RNA genome. Within this group, viruses with a distinct “bullet” shape are classified in the Rhabdoviridae family, which includes at least three genera of animal viruses, Lyssavirus, Ephemerovirus, and Vesiculovirus. The genus Lyssavirus includes rabies virus, Lagos bat virus, Mokola virus, Duvenhage virus, European bat virus 1 & 2, and Australian bat virus. The most common is the rabies virus. The rabies virus is only cause of rabies in the US. The virus can be further classified by slight variation within species that it infects, such as the raccoon variant, canine variant, and bat variant of the rabies virus.

Although the rabies virus can infect a variety of cell types, it primarily targets neurons. The cycle of viral infection is depicted in Figure 1: Transmission of Rabies Through the CNS, on page 9. The virus spreads by retrograde axonal transport from the peripheral nerves to the neuronal cell body. After replication in the cell body of the primary neuron, infection proceeds via retrograde axonal transport and transsynaptic spread through several neurons. Transsynaptic spread is the ability of the virus to use synaptic junctions to propagate within the CNS. Neuronal infection by the rabies virus causes abnormalities in the function of neurotransmitters affecting serotonin, GABA, and muscarinic acetylcholine transmission. Cells of the salivary gland are infected next, which in turn shed virus into the oral cavity. This accounts for the presence of the virus in saliva.

Susceptibility

ALL mammals (animals that are warm-blooded, have hair, fur, or mammary glands) are susceptible to rabies, but there are varying degrees of susceptibility. Birds and reptiles cannot be infected with the rabies virus.

Table 1 Levels of Rabies Susceptibility

Level of Susceptibility	Animals
Most Susceptible	Foxes, coyotes, jackals, and wolves
Highly Susceptible	Skunks, raccoons, bats, ferrets, and cattle
Moderately Susceptible	Dogs and cats (domesticated), sheep, goats, horses, and subhuman primates

Opossums are relatively resistant to rabies and considered a low risk for infection. Experiments have shown that the viral exposure dose required to infect opossums is 80,000 times that needed to infect a fox. Rodents and rabbits are also a relatively low risk for transmitting the rabies virus and seem somewhat refractory to rabies infection. Experimentally infected rodents generally

excrete little or no virus in saliva making the likelihood for transmission negligible. The fox rabies and raccoon rabies viral strains are not well adapted to rodents, other than woodchucks or groundhogs – large rodents which may share habitat with raccoons and foxes and have the capability of surviving an attack from a rabid animal. The Advisory Committee on Immunization Practices of the US Public Health Service states that:

“Small rodents (i.e., squirrels, chipmunks, rats, mice, hamsters, guinea pigs, and gerbils) and lagomorphs (including rabbits and hares) are rarely infected with rabies and have not been known to transmit rabies to humans.”

Only an unprovoked, aggressive attack by a rodent or rabbit with clinical evidence of rabies infection should normally be considered for investigation and rabies treatment/prophylaxis. Domesticated rodents purchased from pet shops, raised in controlled captive breeding, and never exposed to carnivorous animals or bats pose no risk of rabies by biting (i.e., guinea pigs, hamsters, gerbils, mice, and white rats).

Any wild animal, especially wild carnivores and bats, must be considered to be rabid. Since wild animals can have extended incubation periods, they cannot be considered free of rabies even if purchased from a pet shop, acquired as a baby, and/or held for a long period of time. The period of viral shedding in the saliva prior to or after the onset of clinical symptoms is not known for these animals; therefore, an appropriate observation period following an exposure cannot be ascertained.

Animals can acquire the virus not only from bites and scratches with saliva contamination, but also through in-utero infections, nursing, or from eating a dead rabid animal. Although rare, aerosol transmission to humans in bat caves and laboratories and infection via transplanted organs have also been documented.

The public should be warned not to handle wild animals or bats under any circumstances, including injured or sick animals. A disabled animal's chances for survival are much greater with professional assistance from animal control or wildlife management experts. Wild animals that bite humans must not be held for observation, but humanely sacrificed and submitted to the lab for rabies examination.

Transmission

Transmission of rabies virus usually begins when infected saliva of a host is passed to an uninfected animal. Various routes of transmission have been documented and include contamination of mucous membranes (i.e., eyes, nose, and mouth), aerosol transmission, and corneal transplantations. The most common mode of rabies virus transmission is through a bite and/or virus-containing saliva of an infected host.

Following primary infection, the virus enters an eclipse phase in which it cannot be easily detected within the host. This phase may last for several days or months. Investigations have shown both direct entry of virus into peripheral nerves at the site of infection and indirect entry after viral replication in non-neural tissue (i.e., muscle cells). During the eclipse phase, the host immune defenses may confer cell-mediated immunity against viral infection because rabies virus is a good antigen. The uptake of virus into peripheral nerves is important for progressive infection to occur.

After uptake into peripheral nerves, rabies virus is transported to the central nervous system (CNS) via retrograde axoplasmic flow. Typically this occurs via sensory and motor nerves at the initial site of infection. The incubation period (see Figure 14) is the time from exposure to onset of clinical signs of disease. The incubation period may vary from a few days to several years, but is typically 1 to 3 months. Dissemination of virus within the CNS is rapid, and includes early involvement of limbic system neurons. Active cerebral infection is followed by passive centrifugal spread of virus to peripheral nerves. The amplification of infection within the CNS occurs through cycles of viral replication and cell-to-cell transfer of progeny virus. Centrifugal spread of virus may lead to the invasion of highly innervated sites of various tissues, including the salivary glands. During this period of cerebral infection, the classic behavioral changes associated with rabies develop.

Pathology of rabies infection is typically defined by encephalitis and myelitis. Perivascular infiltration with lymphocytes, polymorphonuclear leukocytes, and plasma cells can occur throughout the entire CNS. Rabies infection frequently causes cytoplasmic eosinophilic inclusion bodies (Negri bodies) in neuronal cells, especially pyramidal cells of the hippocampus and Purkinje cells of the cerebellum. These inclusions have been identified as areas of active viral replication by the identification of rabies viral antigen. Several factors may affect the outcome of rabies exposure. These include the virus variant, the dose of virus inoculum, the route and location of exposure, as well as individual host factors, such as age and host immune defenses.

Figure 1 Transmission of Rabies Through the CNS

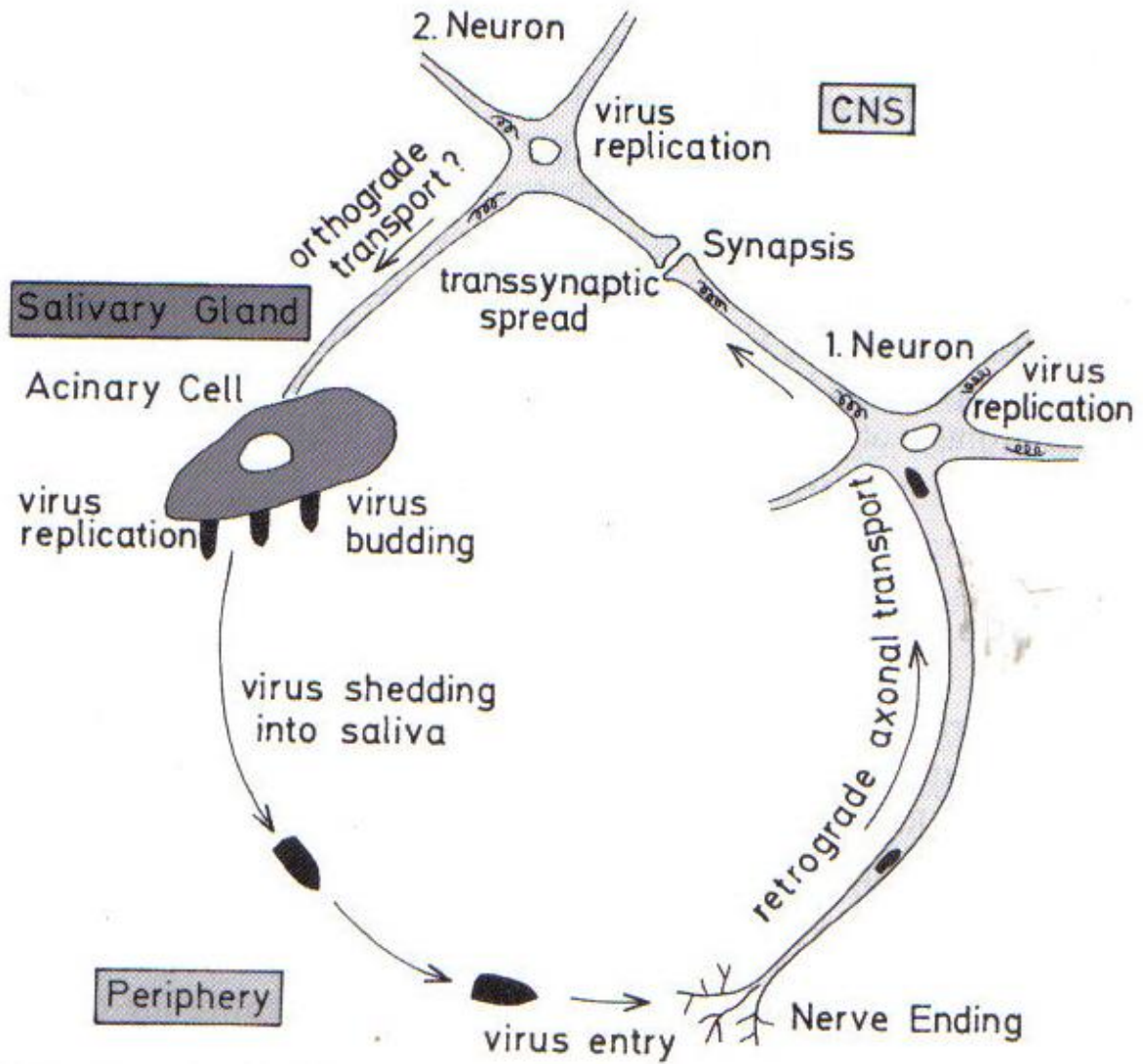

Incubation Period and Duration of Disease

Clinical Signs

The signs and symptoms of rabies in domestic species are similar; however, those in individual animals, even of the same species, can vary widely. Sometimes, a rabies-infected animal can die suddenly, after exhibiting few or no symptoms to the casual observer. Three stages or phrases generally occur in the course of rabies: (1) *Prodromal* or initial stage; (2) *Excitative* (i.e. “furious” rabies in the dog); and (3) *Paralytic* (i.e. “dumb” rabies in the dog). The Excitative stage almost always terminates in paralysis, though occasionally an animal may die during the course of severe convulsions prior to development of full prostration and paralysis. In some animals, the Excitative stage may be slight or absent in which case the clinical picture will be paralysis. Hydrophobia, literally the “fear of water,” is a descriptive term applied to clinical rabies in man and stems from the severe, involuntary, and painful spasms provoked by attempts to drink, or sometimes the mere sight or sound of water. The syndrome does not occur in animals, so the term hydrophobia correctly applies only to rabies in man.

Domestic Animals		
Dogs	Incubation Period	Average 3 – 8 weeks. Known range: 9 days to 8 ½ months
	Prodromal Stage	2 – 3 days duration
	Excitative Stage	1 – 7 days duration, rarely longer than 10-12 days
	Paralytic Stage	1 – 4 days duration
Cats and Ferrets	Incubation Period	Similar to dogs
	Duration of Disease	Similar to dogs
Other Animals		
Horses and Mules	Incubation Period	Average 3 weeks – 3 months; rarely 2 weeks or over 3 months
	Duration of Disease	5 – 8 days
Cattle	Incubation Period	Average 2 – 10 weeks; rarely as long as 6 months
	Duration of Disease	Typically 1 ½ – 6 days; rarely as long as 14 days
Sheep and Goats	Incubation Period	2 – 17 weeks documented
	Duration of Disease	5 – 7 days
Swine	Incubation Period	2 – 4 weeks
	Duration of Disease	2 – 4 days

****If a dog, cat, or ferret is without any signs of abnormality on the 10th or more day after inflicting a bite, it is safe to assume that the animal was NOT shedding virus in saliva (it was NOT INFECTIOUS) at the time of the bite**** This statement, however, cannot be applied to other species of animals. (For more quarantine information, see page 26 of this Manual.)

Control Methods in Humans

Prevention of human rabies is dependent upon providing exposed persons with prompt local treatment of their wounds, combined with appropriate rabies post-exposure prophylaxis (PEP) consisting of both passive and active immunoprophylaxis. Passive immunization consists of rabies antibody administration, while active prophylaxis includes immunization with cell-culture vaccines. In addition, pre-exposure vaccination is recommended for persons more likely to be exposed, such as certain laboratory workers, animal control officers, and veterinarians.

Rabies Biologics

In general, two types of rabies products are available in the US, namely, rabies vaccines and rabies immunoglobulin. Rabies vaccines induce an active immune response that includes the production of neutralizing antibodies. This antibody response requires approximately 7-10 days to develop and usually persists for greater than or equal to 2 years. Rabies immune globulin (RIG) provides a rapid, passive immunity that persists for only a short time (half-life of approximately 21 days).

Two formulations of inactivated vaccines are currently licensed for pre-exposure and post-exposure prophylaxis in the US (see below). When used as indicated, both types of rabies vaccines are considered equally safe and efficacious. A full 1.0 mL intramuscular (IM) dose is used for pre-exposure and post-exposure prophylactic injection. There are no currently approved formulations for the intradermal dose and route for pre-exposure vaccination; both types of vaccines must be administered intramuscularly. Usually, an immunization series is initiated and completed with one vaccine product; however, no clinical studies have been conducted that document a change in efficacy or the frequency of adverse reactions when the series is completed with a second vaccine product.

Vaccines

1. **Human Diploid Cell Vaccine (HDCV):** HDCV is prepared from the Pitman-Moore strain of rabies virus grown on MRC-5 human diploid cell culture, concentrated by ultra-filtration, and inactivated with beta-propiolactone. It is approved for **intramuscular (IM) administration only**, and is supplied in a single-dose vial containing lyophilized vaccine that is reconstituted in the vial with the accompanying diluents to a final volume of 1.0 mL just before administration.

- Manufacturer: Sanofi Pasteur
- Product Name: *Imovax Rabies* ®

2. **Purified Chick Embryo Cell Vaccine (PCEC):** PCEC became available in the US in the autumn of 1997. It is prepared from the fixed rabies virus strain Flury LEP grown in primary cultures of chicken fibroblasts. The virus is inactivated

with beta-propiolactone and further processed by zonal centrifugation in a sucrose density gradient. It is formulated for **IM administration only**. PCEC is available in a single-dose vial containing lyophilized vaccine that is reconstituted in the vial with the accompanying diluents to a final volume of 1.0 mL just before administration.

- Manufacturer: Novartis Vaccines and Diagnostics
- Product Name: *RabAvert* ®

A. Rabies Immune Globulin (RIG)

1. The two RIG products licensed in the US are rabies immunoglobulin (IgG) preparations concentrated by cold ethanol fractionation from plasma of hyper-immunized human donors. Rabies neutralizing antibody, standardized at a concentration of 150 IU per mL, is supplied in 2 mL (300 IU) vials for pediatric use and 10 mL (1,500 IU) vials for adult use; the recommended dose is 20 IU/kg body weight. Both RIG preparations are considered equally efficacious when used as described.

- Manufacturer: Talecris Biotherapeutics and Sanofi Pasteur
- Product Name: *HyperRab*TM S/D and *Imogam Rabies – HT* ®

Assessing the Need for PEP

Administration of rabies PEP is a medical urgency, not a medical emergency. Persons who have been bitten by animals suspected or proven to be rabid should begin PEP as soon as possible. However, very long incubation periods (up to 1 year) have been reported in humans. Thus, when a documented or likely exposure has occurred, PEP is indicated regardless of the length of the delay, provided the clinical signs of rabies are not present. Under most circumstances, PEP should not be initiated if the bite was from a healthy dog/cat/ferret that is available for a 10-day quarantine. However, if during the 10-day quarantine period, the animal begins to show signs of rabies, the PEP should be started immediately and the animal tested as soon as possible.

Health care providers should evaluate each possible exposure to rabies and when necessary consult with the Alabama Department of Public Health regarding the need for rabies PEP.

In the US, the following factors should be considered in the rabies risk assessment before PEP is initiated:

- Type of exposure (bite vs. non-bite)
- The geographic location of the incident
- The type of animal that was involved
- Circumstances of the exposure (provoked or unprovoked)
- The vaccination status of the animal
- Whether the animal can be safely captured and tested for rabies

In general, the highest risk of rabies transmission is associated with bite exposure from terrestrial wild carnivores or bats (see **Rabies Treatment Decision Flow Chart**). Raccoons, skunks, foxes, and coyotes are the terrestrial animals most often infected with rabies. All bites by such wildlife must be considered possible exposures to the rabies virus. PEP should be initiated as soon as possible after patients are exposed to wildlife unless the animal has already been tested and shown not to be rabid. In addition, bats are increasingly implicated as important wildlife reservoirs for variants of rabies virus transmitted to humans. In all instances of potential human exposures involving bats, the bat in question should be safely collected, if possible, and submitted for rabies diagnosis. Rabies PEP is recommended for all persons with a bite, scratch, or mucous membrane exposure to a bat, unless the bat is available for testing and is negative for evidence of rabies. PEP might also be appropriate even if a bite, scratch, or mucous membrane exposure is not apparent when there is reasonable probability that such exposure might have occurred.

The likelihood of rabies in a domestic animal varies by region; hence, the need for PEP also varies. In the continental US, rabies among dogs is reported most commonly along the US-Mexico border and sporadically in area of the US with enzootic wildlife rabies. During most of

the 1990s, more cats than dogs were reported rabid in the US. The majority of these cases were caused by the raccoon variant in the eastern US. The large number of rabies-infected cats might be attributed to fewer cat vaccination laws, fewer leash laws, and the roaming habits of cats. In many developing countries, dogs are the major vector of rabies; exposures to dogs in such countries represent an increased risk of rabies transmission. In the United States, a currently vaccinated dog, cat, or ferret is unlikely to become infected with rabies. Although all species of livestock are susceptible to rabies, they are infrequently found to be infected. Small rodents (i.e., squirrels, hamsters, guinea pigs, gerbils, chipmunks, rats, and mice) and lagomorphs (including rabbits and hares) are almost never found to be infected with rabies and have not been known to transmit rabies to humans.

An unprovoked attack by an animal is more likely than a provoked attack to indicate that the animal is rabid. Bites inflicted on a person attempting to feed or handle an apparently healthy animal should generally be regarded as provoked.

Refer to the chart below and to the Rabies Treatment Decision Flow Chart on the proceeding pages for specific guidelines.

Table 1. Rabies Post-Exposure Prophylaxis Schedule – US, 2008

Animal Type	Evaluation and Disposition of Animal	Exposure Prophylaxis Recommendations
Dogs, Cats, and Ferrets	<ul style="list-style-type: none"> • Healthy and available for 10 day quarantine • Rabid or suspected rabid • Unknown (i.e., escaped) 	<ul style="list-style-type: none"> • Persons should not begin PEP unless animal develops clinical signs of rabies.* • Immediate PEP. • Consult local rabies officer or Alabama Department of Public Health officials
Skunks, raccoons, bobcats, foxes, and most other carnivores; bats	Regarded as rabid unless animal proven negative by laboratory tests. **	Consider immediate PEP
Livestock, small rodents, lagomorphs (rabbits and hares), large rodents (woodchucks and beavers), and other mammals	Consider individually.	Consult local rabies officer or Alabama Department of Public Health officials. Bites of squirrels, hamsters, mice, and rats, most other rodents, and rabbits almost never require PEP. Large rodents may be a risk.

* During the 10-day quarantine period, begin PEP at the first sign of rabies in a dog, cat, or ferret that has bitten someone. If the animal exhibits clinical signs of rabies, it should be euthanized immediately and tested.

** The animal should be euthanized and tested as soon as possible. Discontinue vaccine if rabies test results are negative.

Definitions

Exposure is any contact with saliva or brain/nervous tissue through open cuts in the skin, scratches, or mucous membrane (mouth or eyes).

PEP is postexposure prophylaxis or treatment, which usually includes HRIG and 4-doses of rabies vaccine.

Provoked is an intentional act that causes the animal to react in a hostile manner.

Quarantine is separating suspected animal from other animals and people.

Signs of rabies include obvious changes in normal behavior, like aggression, attack without reason, foaming at mouth, no interest in food or water, stagger, tired, or paralysis. In wild animals, they may act very tame.

Uncertain exposure can occur with bats because they have small teeth and may leave marks that are not easily seen.

For more information, go to www.adph.org/epi. Rabies to review the Rabies Bite Manual, Alabama Rabies Law, Rabies data, and CDC Rabies links. For questions, please call the Epidemiology Division, Zoonotic Branch at 1-800-338-8374.

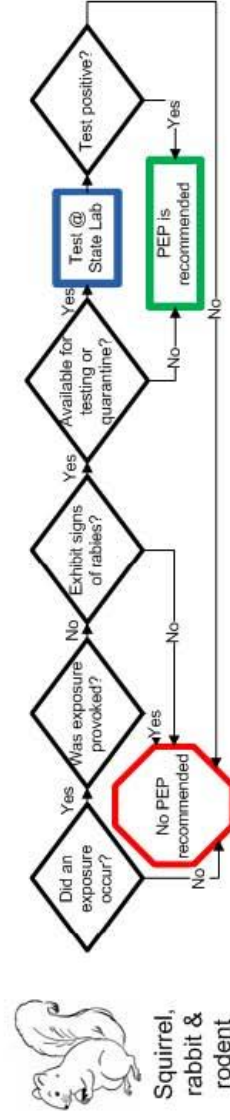
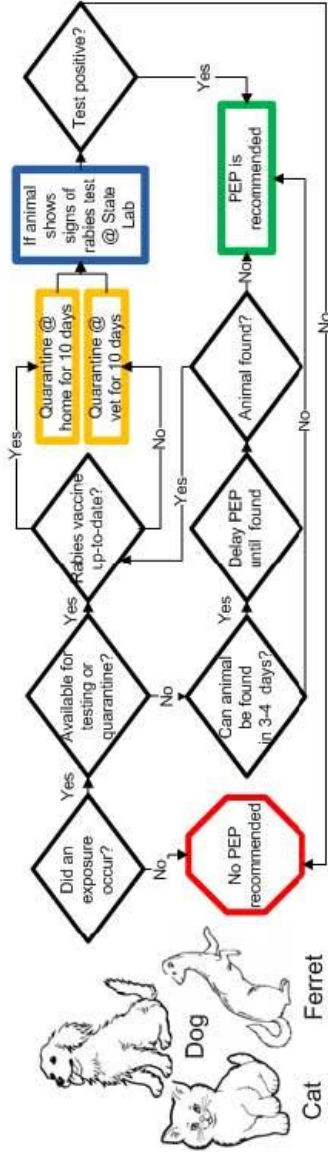
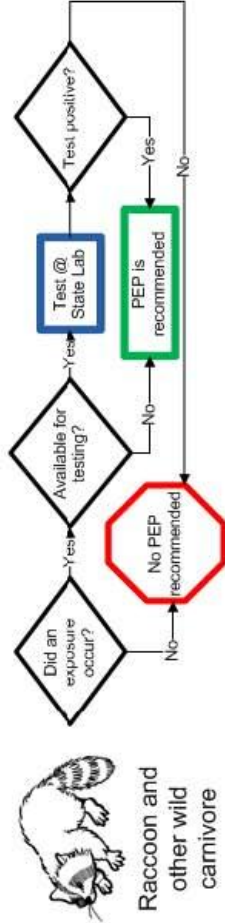
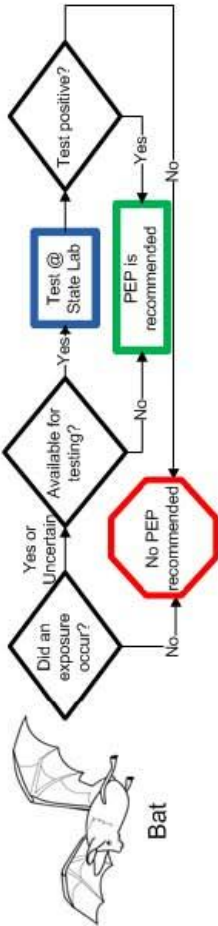

For large animals, like cows and horses, please contact Epidemiology Division, Zoonotic Branch, 1-800-338-8374.

Rabies Post-Exposure Vaccination for Humans

In general, post-exposure prophylaxis (PEP) is indicated for persons exposed to a rabid animal in order to prevent infection with rabies virus. The ADPH follows the most recent recommendations from ACIP in the *Morbidity and Mortality Weekly Report (MMWR)* “Use of a Reduced (4 Dose) Vaccine Schedule for Postexposure Prophylaxis to Prevent Human Rabies.” These recommendations reduce the number of vaccine doses to four. The reduction in doses recommended for PEP was based in part on evidence from rabies virus pathogenesis data experimental animal work, clinical studies, and epidemiologic surveillance. These studies indicated that 4 vaccine doses in combination with rabies immune globulin (RIG) elicited adequate immune responses and that a fifth dose of vaccine did not contribute to more favorable outcomes. For persons previously vaccinated with rabies vaccine, the reduced regimen of 4 1-mL doses of HDCV or PCECV should be administered intramuscularly. The first dose of the 4-dose course should be administered as soon as possible after exposure (day 0). Additional doses then should be administered on days 3, 7, and 14 after the first vaccination. ACIP recommendations for the use of RIG remain unchanged. For persons who previously received a complete vaccination series (pre-or postexposure prophylaxis) with a cell-culture vaccine or who previously had a documented adequate rabies virus-neutralizing antibody titer following vaccination with non cell-culture vaccine, the recommendation for a 2-dose PEP vaccination series has not changed. Similarly, the number of doses recommended for persons with altered immunocompetence has not changed; for such persons, PEP should continue to comprise a 5-dose vaccination regimen with 1 dose of RIG. Recommendations for pre-exposure prophylaxis also remain unchanged with 3 doses of vaccine administered on days 0, 7, and 21 or 28. Prompt rabies PEP combining wound care, infiltration of RIG into and around the wound, and multiple doses of rabies cell-culture vaccine continue to be highly effective in preventing human rabies. See Table 2 on page 19 for specific schedule and administration instructions.

Rabies Post-exposure Prophylaxis (PEP) for Non-immunized People

Treatment	Regimen
Wound Cleansing	Clean immediately with soap and water. If possible, irrigate wound with a anti-virus agent, like povidine-iodine
HRIG	If possible, full dose infiltrated around the wound. Any remaining should be administered intramuscularly (IM), at site distant from the vaccine.
Rabies Vaccine	4 doses, 1 ml, IM, upper arm area, days 0, 3, 7, and 14

Immunosuppression

Recommendations for rabies pre- and postexposure prophylaxis for persons with immunosuppression have not changed. General recommendations for active and passive immunization in persons with altered immunocompetence have been summarized previously ([27,28](#)). This updated report discusses specific recommendations for patients with altered immunocompetence who require rabies pre- and postexposure prophylaxis. All rabies vaccines licensed in the United States are inactivated cell-culture vaccines that can be administered safely to persons with altered immunocompetence. Because corticosteroids, other immunosuppressive

agents, antimalarials, and immunosuppressive illnesses might reduce immune responses to rabies vaccines substantially, for persons with immunosuppression, rabies PEP should be administered using a 5-dose vaccine regimen (i.e., 1 dose of vaccine on days 0, 3, 7, 14, and 28), with the understanding that the immune response still might be inadequate. Immunosuppressive agents should not be administered during rabies PEP unless essential for the treatment of other conditions. If possible, immunosuppressed patients should postpone rabies preexposure prophylaxis until the immunocompromising condition is resolved. When postponement is not possible, immunosuppressed persons who are at risk for rabies should have their virus-neutralizing antibody responses checked after completing the preexposure series. Post vaccination rabies virus-neutralizing antibody values might be less than adequate among immunosuppressed persons with HIV or other infections (29,30). When rabies pre- or postexposure prophylaxis is administered to an immunosuppressed person, one or more serum samples should be tested for rabies virus-neutralizing antibody by the RFFIT to ensure that an acceptable antibody response has developed after completing the series. If no acceptable antibody response is detected after the final dose in the pre- or postexposure prophylaxis series, the patient should be managed in consultation with their physician and appropriate public health officials.

Variation from Human Rabies Vaccine Package Inserts

These new ACIP recommendations differ from current rabies vaccine label instructions, which still list the 5-dose series for PEP. Historically, ACIP review and subsequent public health recommendations for the use of various biologics have occurred after vaccine licensure and generally are in agreement with product labels. However, differences between ACIP recommendations and product labels are not unprecedented. For example, during the early 1980s, ACIP review and recommendations concerning the intradermal use of rabies vaccines occurred well in advance of actual label claims and licensing (9). On the basis of discussions with industry representatives, alterations of current product labels for HDCV and PCEC are not anticipated by the producers of human rabies vaccines licensed for use in the United States.

HRIG Dose Chart

20 International Units (IU) per kilogram (kg) or 0.133 milliliters (ml) per kg for all age groups

Weight in lb	Weight in kg	Dose in IU	Dose in ml	Weight in lb	Weight in kg	Dose in IU	Dose in ml
11	5	100	0.7	121	55	1100	7.3
13	6	120	0.8	132	60	1200	8
18	8	160	1.1	143	65	1300	8.7
22	10	200	1.3	154	70	1400	9.3
26	12	240	1.6	165	75	1500	10
31	14	280	1.9	176	80	1600	10.7
35	16	320	2.1	187	85	1700	11.3
40	18	360	2.4	198	90	1800	12
44	20	400	2.7	209	95	1900	12.7
55	25	500	3.3	220	100	2000	13.3
66	30	600	4	231	105	2100	14
77	35	700	4.7	242	110	2200	14.7
88	40	800	5.3	253	115	2300	15.3
99	45	900	6	264	120	2400	16
110	50	1000	6.7	276	125	2500	16.6

Ordering Information for Rabies Immune Globulin (RIG) and Rabies Vaccine

Rabies Immune Globulin (RIG) and rabies vaccine can be ordered by a licensed physician or through a pharmacist directly from the manufacturer. At this time, ADPH is recommending the use of “Imovax” from Sanofi Pasteur or “RabAvert” from Novartis. Use of a licensed Rabies Immune Globin is also available from each manufacturer.

Sanofi Pasteur 1-800-VACCINE (1-800-822-2463)

Novartis 1-877-683-4732

Talecris 1-800-243-4153

Programs for Uninsured and Underinsured Patients

Patient assistance programs that provide medications to uninsured or underinsured patients are available for rabies vaccine and Immune globulin.

Sanofi Pasteur's Patient Assistance Program (providing Imogam ® Rabies-HT and Imovax ® Rabies as well as other vaccines) is now administered through the Franklin Group. A healthcare professional or patient can either contact the Franklin Group directly, or call the customer service team (1-800-VACCINE) who will transfer them to the Franklin Group. The Franklin Group will review the application against the eligibility criteria. For more information about the program or to request an application, please contact the Sanofi Pasteur, Inc. Patient Assistance Program (Franklin Group) at 1 (866) 801-5655.

Novartis' Patient Assistance Program for RabAvert ® is managed through RX for Hope and can be accessed at 1-800-589-0837. Instructions and request forms are also available at the Rx for Hope website RabAvert Patient Assistance Program. Instructions and request forms are also available at the Sanofi Patient Connection website.

TABLE 2. Rabies postexposure prophylaxis (PEP) schedule --- United States, 2010		
Vaccination status	Intervention	Regimen*
Not previously vaccinated	Wound cleansing	All PEP should begin with immediate thorough cleansing of all wounds with soap and water. If available, a virucidal agent (e.g., povidine-iodine solution) should be used to irrigate the wounds.
	Human rabies immune globulin (HRIG)	Administer 20 IU/kg body weight. If anatomically feasible, the full dose should be infiltrated around and into the wound(s), and any remaining volume should be administered at an anatomical site (intramuscular [IM]) distant from vaccine administration. Also, HRIG should not be administered in the same syringe as vaccine. Because RIG might partially suppress active production of rabies virus antibody, no more than the recommended dose should be administered.
	Vaccine	Human diploid cell vaccine (HDCV) or purified chick embryo cell vaccine (PCECV) 1.0 mL, IM (deltoid area†), 1 each on days 0,§ 3, 7 and 14.¶ +Deviations from this schedule should be avoided.
Previously vaccinated**	Wound cleansing	All PEP should begin with immediate thorough cleansing of all wounds with soap and water. If available, a virucidal agent such as povidine-iodine solution should be used to irrigate the wounds.
	HRIG	HRIG should not be administered.

	Vaccine	HDCV or PCECV 1.0 mL, IM (deltoid area†), 1 each on days 0§ and 3.
<p>* These regimens are applicable for persons in all age groups, including children.</p> <p>† The deltoid area is the only acceptable site of vaccination for adults and older children. For younger children, the outer aspect of the thigh may be used. Vaccine should never be administered in the gluteal area.</p> <p>+Deviations from this protocol should be avoided. However, small deviations from this schedule (e.g. missing a dose) appear to have minimal effect on immunization provided the intervals between the vaccines are maintained. Consultation is available if you have concerns about vaccine administration.</p> <p>§ Day 0 is the day dose 1 of vaccine is administered.</p> <p>¶ For persons with immunosuppression, rabies PEP should be administered using all 5 doses of vaccine on days 0, 3, 7, 14, and 28.</p> <p>** Any person with a history of pre-exposure vaccination with HDCV, PCECV, or rabies vaccine adsorbed (RVA); prior PEP with HDCV, PCECV or RVA; or previous vaccination with any other type of rabies vaccine and a documented history of antibody response to the prior vaccination.</p>		

Rabies Pre-Exposure Vaccination for Humans

Pre-exposure vaccination should be offered to persons in continuous or frequent-risk groups, such as veterinarians, animal handlers, and certain laboratory workers. Pre-exposure vaccination also should be considered for other persons whose activities bring them into frequent contact with rabies virus or potentially rabid bats, raccoons, skunks, cats, dogs, or other species at risk for having rabies. In addition, international travelers might be candidate for pre-exposure vaccination if they are likely to come in contact with animals where canine rabies is endemic and immediate access to appropriate medical care, including rabies biologics, might be limited.

Pre-exposure prophylaxis is administered for several reasons. First, although pre-exposure vaccination does not eliminate the need for additional therapy following a rabies exposure, it simplifies therapy by eliminating the need for RIG administration and decreasing the number of doses of vaccine needed – a point of particular importance for person at high risk for being exposed to rabies in areas where immunizing products might not be available or where they might be at high risk for adverse reactions. Second, pre-exposure prophylaxis might protect persons whose post-exposure therapy is delayed. Finally, it might provide protection to persons at risk for unapparent exposures to rabies

Rabies pre-exposure prophylaxis guide – U.S. 2008

Risk category	Nature of risk	Typical populations	Pre-exposure recommendations
Continuous	Virus present continuously, often in high concentrations. Specific exposures likely to go unrecognized. Bite, nonbite, or aerosol exposure.	Rabies research laboratory workers; rabies biologics production workers.	Primary course. Serologic testing every 6 months; booster vaccination if antibody titer is below acceptable level.*
Frequent	Exposure usually episodic, with source recognized, but exposure also might be unrecognized. Bite, nonbite, or aerosol exposure.	Rabies diagnostic laboratory workers, cavers, veterinarians and staff, and animal-control and wildlife workers in areas where rabies is enzootic. All persons who frequently handle bats.	Primary course. Serologic testing every 2 years; booster vaccination if antibody titer is below acceptable level.*
Infrequent (greater than population at large)	Exposure nearly always episodic with source recognized. Bite or nonbite exposure.	Veterinarians and animal-control staff working with terrestrial animals in areas where rabies is uncommon to rare. Veterinary students. Travelers visiting areas where rabies is enzootic and immediate access to appropriate medical care including biologics is limited.	Primary course. No serologic testing or booster vaccination.
Rare (population at large)	Exposure always episodic with source recognized. Bite or nonbite exposure.	U.S. population at large, including persons in areas where rabies is epizootic.	No vaccination necessary.

* Minimum acceptable antibody level is complete virus neutralization at a 1:5 serum dilution by the rapid fluorescent focus inhibition test. A booster dose should be administered if the titer falls below this level.

Pre-exposure vaccination consists of two regimens: a primary vaccination regimen and a booster regiment. The primary vaccination regiment consists of three 1.0 mL injections of HDCV or PCEC that are administered intramuscularly (IM) in the deltoid area. One injection should be given per day on days 0, 7, and 21 or 28. Day 0 is defined as the day the first dose of vaccination is administered. If a booster vaccination is recommended, a single 1.0 mL injection of HDCV or PCEC should be administered intramuscularly (IM) in the deltoid area. For more information please refer to the *2008 Compendium of Animal Rabies Prevention and Control*.

Rabies Pre-exposure Prophylaxis

Rabies Vaccine	3 doses, 1 mL, IM, days 0, 7, and 21
----------------	--------------------------------------

Post-exposure Prophylaxis (PEP) for Previously Immunized People

For people exposed to rabies and have been previously vaccinated with either the recommended pre-exposure OR post-exposure regimen should receive two 1.0 mL doses IM of vaccine, immediately after exposure on day 0, followed by an additional dose on day 3. HRIG is not necessary and should not be administered.

Rabies Post-exposure Prophylaxis (PEP) for Previously Immunized People

Treatment	Regimen
Wound Cleansing	Clean immediately with soap and water. If possible, irrigate wound with a anti-virus agent, like povidine-iodine
HRIG	Do not administer
Rabies Vaccine	2 doses, 1 mL, IM, days 0 and 3

Serologic Response and Pre-Exposure Booster Doses of Vaccine

Although virus neutralizing antibody levels might not definitively determine a person's susceptibility or protection from a rabies virus exposure, titers in persons at risk for exposure are used to monitor the relative rabies immune status over time. To ensure the presence of a primed immune response over time among persons at higher than normal risk for exposure, titers should be checked periodically, with booster doses administered only as needed. Two years after primary pre-exposure vaccination, a complete neutralization of challenge virus at a dilution of 1:5 (by the RFFIT) was observed among 93%-98% of persons who received the 3-dose pre-exposure series intramuscularly and 83%-95% of persons who received the 3-dose series intradermally. If the titer falls below the minimum acceptable antibody level of complete neutralization at a serum dilution of 1:5, a single pre-exposure booster dose of vaccine is recommended for persons at continuous or frequent risk for exposure to rabies. The following guidelines are recommended for determining when serum testing should be performed after primary pre-exposure vaccination:

- A person in the continuous-risk category should have a serum sample tested for rabies virus neutralizing antibody every 6 months.
- A person in the frequent-risk category should have a serum sample tested for rabies virus neutralizing antibody every 2 years.

The Alabama Department of Public Health can provide the names and addresses of laboratories performing appropriate rabies virus neutralizing serologic testing.

Human Diploid Cell Vaccine (HDCV)

Studies of HDCV recipients reported local reactions (i.e., pain at the injection site, redness, swelling, induration) among 60-89.5% of recipients. Most local reactions were mild and resolved spontaneously within a few days. Local pain at the injection site was the most frequently reported adverse reaction occurring in 21-77% of those receiving the vaccine. Mild

systemic reactions (i.e., fever, headache, dizziness, gastrointestinal symptoms) were reported in 6.8-55.6% of recipients.

Immediate systemic hypersensitivity reactions were observed in 1.2% of recipients in one study involving boosters of HDCV one year after primary vaccination with HDCV. Immediate hypersensitivity reactions have been reported in as many as 6% of persons receiving booster vaccination with HDCV following primary rabies prophylaxis; 3% occurring within one day of receiving boosters and 3% occurring 6-14 days after boosters. Systemic allergic reactions have been associated with the presence of betapropiolactone-altered human albumin in HDCV and the development of antibodies to this allergen. No deaths resulting from these reactions have been reported.

Purified Chick Embryo Cell Vaccine (PCEC)

In studies of PCEC use, local reactions (i.e., pain at the injection site, redness, and swelling) were reported among 11-57% of recipients. Local pain at the injection site, the most common local reaction, was reported in 2-23% of those receiving the vaccine. Systemic reactions were less common, and have been reported in 0-31% of vaccine recipients. In one study, 7% of children administered PCEC experienced mild to moderate clinical reactions.

In another study reviewing adverse events following the administration of PCEC using data from the United States Vaccine Adverse Events Reporting System (VAERS), approximately 1.1 million doses of PCEC were distributed (from 1997-2005) and 331 reports describing adverse events following PCEC administration were received by VAERS. A total of 196 reported adverse events (3% serious) occurred following administration of PCEC alone, and 135 (10% serious) occurred following post-exposure prophylaxis (PCEC co-administered with HRIG) or PCEC administered concomitantly with another vaccine. A total of 20 reports, three serious, were classified as anaphylaxis. One patient was found to be allergic to gelatin, a vaccine component. Among the 309 non-serious adverse events, the most frequently reported were headache, fever, myalgia, nausea, and weakness. A limitation of VAERS is that causality between vaccine administration and reported adverse events cannot be established. No deaths or rabies cases were reported following the administration of PCEC.

Human Rabies Immune Globulin (HRIG)

In a clinical trial involving 16 volunteers, participants receiving HRIG alone (no vaccine) commonly reported local reaction (100% in conventional HRIG group, 75% in heat-treated HRIG group), including pain/tenderness (100% conventional HRIG group, 50% heat-treated HRIG group), erythema (63% conventional HRIG, 25% heat-treated HRIG), and induration (50% conventional, 31% heat-treated). Systemic reactions were reported in 75% of participants in the conventional HRIG group and 81% in the heat-treated group. Headache was the most commonly reported systemic reaction (50% conventional, 69% heat-treated). Most of the reported local and systemic reactions were mild, and there were no significant differences in the frequency of adverse events between treatment groups.

Neurological Adverse Events

Rare, individual case reports of neurologic adverse events following rabies vaccination have been reported but in none of the cases has causality been established. Five cases of neurologic illness resembling Guillain-Barré syndrome occurring after treatment with HDCV or PCEC have been identified. One case of acute neurologic syndrome involving seizure activity was reported following the administration of HDCV and human RIG. Other central and peripheral nervous system disorders have been temporally associated with HDCV vaccine.

Management of Adverse Reactions

Once initiated, rabies prophylaxis should not be interrupted or discontinued because of local or mild systemic adverse reactions to rabies vaccine. Usually, such reactions can be successfully managed with anti-inflammatory and antipyretic agents, such as ibuprofen or acetaminophen.

When a person with a history of serious hypersensitivity to rabies vaccine must be revaccinated, antihistamines can be administered. Epinephrine should be readily available to counteract anaphylactic reactions, and the person should be observed carefully immediately after vaccination.

Although serious systemic, anaphylactic, or neuroparalytic reactions are rare during and after the administration of rabies vaccines, such reactions pose a serious dilemma for the patient and the attending physician. A patient's risk of acquiring rabies must be carefully considered before deciding to discontinue vaccination. Advice and assistance on the management of serious adverse reactions for persons receiving rabies vaccines may be sought from the Alabama Department of Public Health.

All clinically significant adverse events occurring following administration of rabies biologics should be reported to the Vaccine Adverse Event Reporting System (VAERS), even if causal relation to vaccination is not certain. Although VAERS is subject to limitations common to passive surveillance systems, including underreporting and reporting bias, it is a valuable tool for characterizing the safety profile of vaccines and identifying risk factors for rare serious adverse reactions to vaccines. VAERS reporting forms and information are available electronically at <http://www.vaers.hhs.gov/> or by telephone via a 24-hour toll-free telephone number (1-800-822-7967). Web-based reporting is available at <https://secure.vaers.org/VaersDataEntryintro.htm>* to promote better timeliness and quality of safety data.

Animal Vaccination Protocols

Public Health laws in Alabama (Section 3-7A of the Code of Alabama 1975) mandate that parenteral animal rabies vaccines can be administered only by a licensed veterinarian. This is to ensure accountability and assurance that the animal has been properly vaccinated. An animal is considered currently vaccinated if the primary vaccination was administered by a licensed veterinarian at least 28 days previously. Regardless of the age of the animal at initial vaccination, a second vaccination should be administered 1 year later. Because a rapid anamnestic (memory) response is expected, an animal is considered currently vaccinated immediately after a booster vaccination.

- **Dogs, Cats, and Ferrets**

All dogs, cats and ferrets are required by Alabama Law to be vaccinated against rabies. They should be vaccinated in accordance with the Code of the Alabama, Title 3. If a previously vaccinated animal is overdue for a booster, it should be revaccinated with a single dose of vaccine and placed on an interval in accordance with the vaccine's label.

- **Livestock**

Vaccinating all livestock against rabies is neither economically feasible nor justified from a public health standpoint. However, strong consideration should be given to vaccinating livestock that are particularly valuable or that might have frequent contact with humans, such as show animals or those in petting zoos. (For specific vaccines licensed for use in livestock, please see the Currently FDA Licensed Rabies Vaccines Section on page 43 of this Manual.) It is recommended that horses traveling interstate or with significant public contact (riding stables, etc.) should be currently vaccinated against rabies.

- **Other Animals**

- **Wild Animals**

No parenteral rabies vaccine is licensed for use in wild animals; therefore the ADPH does not recommend any wild animal be immunized against rabies. Additionally, because of the risk of rabies in wild animals (especially raccoons, skunks, coyotes, foxes, and bats), the Alabama Department of Conservation and Natural Resources has rigid regulations which prohibit the ownership of wild and wild/domestic hybrids as pets. For further information, please see www.dcnr.alabama.gov

- **Maintained in Exhibits and in Zoological Parks**

Captive animals that are not completely excluded from all contact with rabies vectors can become infected with rabies. Moreover, wild animals might be incubating rabies when initially captured; therefore, wild-caught animals susceptible to rabies should be placed in strict isolation for a minimum of 6 months before being exhibited. Employees who work with animals at such facilities should consider pre-exposure vaccination prophylaxis. The use of pre- or post-exposure rabies vaccinations for employees who work with animals at

such facilities might reduce the need for euthanasia of captive animals. Carnivores and bats should be housed in a manner that precludes direct contact with the public.

Management of Animals Exposed to Rabies

Any animal potentially exposed to rabies virus by a wild, carnivorous mammal or a bat that is not available for testing should be regarded as having been exposed to rabies, and should be reported to the Alabama Department of Public Health.

Dogs, Cats, and Ferrets

- **Unvaccinated** dogs, cats, and ferrets exposed to a known rabid animal are recommended to be euthanized immediately. If the owner is unwilling to have this done, the animal must be placed in strict isolation for 6 months and vaccinated either upon entry to isolation OR one month prior to release. Animals with expired vaccinations need to be evaluated on a case-by-case basis. Strict isolation should be conducted under the authority of the county health department in which the place, manner, and provisions of the confinement are specified. At the first sign of illness or behavioral change in the animal, the county health department should be notified and the animal should be evaluated by a veterinarian. If clinical signs are suggestive of rabies, the animal should be immediately euthanized and tested for rabies.
- **Currently vaccinated** dogs, cats, and ferrets to a known rabid animal should be revaccinated immediately, kept under the owner's control, and observed at home for 45 days for clinical signs of rabies. During the observation period the animal should not be permitted to roam freely and should be restricted to leash walks, if applicable. At the first sign of illness or behavioral change in the animal, the local rabies control agency should be notified and the animal should be evaluated by a veterinarian. If clinical signs are suggestive of rabies, the animal should be immediately euthanized and tested for rabies.

Horses

The Alabama Department of Public Health should be consulted for all possible rabies exposure in horses.

- All species of livestock are susceptible to rabies; horses and cattle are the most frequently infected. Horses exposed to a rabid animal and **currently vaccinated** with a vaccine approved by the USDA or FDA for that species should be revaccinated immediately and observed for 45 days.
- **Unvaccinated** horses should be euthanized immediately. If the animal is not euthanized it should be kept under close observation for 6 months. Any illness in an animal under observation should be reported immediately to the local health department. If signs suggestive of rabies develop, the animal should be euthanized and the head shipped for testing.
- Barrier precautions should be used by persons handling the animal and tissues.

- Multiple rabid animals in a herd or herbivore-to-herbivore transmission are uncommon; therefore, restricting the rest of the herd if a single animal has been exposed to or infected by rabies is usually not necessary.

Cattle and Sheep

The Alabama Department of Public Health should be consulted for all possible rabies exposure in cattle and sheep.

- Cattle and sheep exposed to a rabid animal and **currently vaccinated** with a vaccine approved by the USDA for that species should be revaccinated immediately and observed for 45 days or be slaughtered.
- **Unvaccinated** cattle and sheep should be euthanized immediately. If the animal is not euthanized it should be kept under close observation for 6 months. Any illness in an animal under observation should be reported immediately to the local health department. If signs suggestive of rabies develop, the animal should be euthanized.
- If an exposed animal is to be slaughtered for consumption, it should be done immediately after exposure. Handling and consumption of tissues from exposed animals may carry a risk for rabies transmission. Risk factors depend in part on the site(s) of exposure, amount of virus present, severity of wounds, and whether sufficient contaminated tissue has been excised. Federal regulation prohibits the slaughter of animals known to be exposed to a known positive rabid animal. Historically, federal guidelines for meat inspectors required that any animal known to have been exposed to rabies within 8 months be rejected for slaughter. USDA Food and Inspection Service meat inspectors should be notified if such exposures occur in food animals prior to slaughter.
- If the animal is privately slaughtered, barrier precautions should be used by persons handling the animal and tissues, and all tissues should be cooked thoroughly. If the animal is slaughtered within 7 days of being exposed and provided that tissues in the exposed areas are discarded, the meat can be consumed without risk. Proper cooking and pasteurizations is effective in killing the rabies virus. Drinking pasteurized milk from an exposed animal is not considered a human exposure
- Rabies virus may be widely distributed in tissues of infected animals. Tissues and products from a rabid animal should not be used for human or animal consumption. However, pasteurization temperatures will inactivate rabies virus; therefore, drinking pasteurized milk or eating thoroughly cooked animal products does not constitute a rabies exposure.
- Multiple rabid animals in a herd or herbivore-to-herbivore transmission are uncommon; therefore, restricting the rest of the herd if a single animal has been exposed to or infected by rabies is usually not necessary.

Other Animals

- Other animals bitten by a rabid animal should be euthanized immediately. Animals maintained in USDA-licensed research facilities or accredited zoological parks should be

evaluated on a case-by-case basis. Consultations can be provided by the Zoonosis Branch, Epidemiology Division, Alabama Department of Public Health.

Management of Animals that Bite Humans

Dogs, Cats, and Ferrets

- A healthy dog, cat, or ferret that bites a person should be quarantined for 10 days, **regardless of current vaccination status**. Administration of rabies vaccine is not recommended during the quarantine period so as not to induce any adverse vaccination reactions (e.g. lameness) that could be characterized as neurological disease.
- At the first sign of illness or behavioral change in the animal, the local county health department and/or the state health department agency should be notified and the animal should be evaluated by a veterinarian. If clinical signs are suggestive of rabies, the animal should be euthanized immediately and tested. Following a positive rabies test result, the local county health department should notify any persons or animal owners who might have been exposed to the rabid animal of the test results.
- The animal must be quarantined with a licensed veterinarian unless the animal qualifies for home quarantine.
- Home quarantine is allowed if the animal is an assistance animal and meets all the criteria specified in *Rules of the Alabama State Board of Health Bureau of Communicable Disease*, Chapter 420-4-4 Rabies Control Program pages 61-62.
- For further information concerning quarantines, please contact your local health department or Alabama Department of Public Health at 1-800-338-8374 or 334-206-5969.

Other biting animals (wild animals, animals maintained in zoological parks, canine or feline wild/domestic hybrids, etc.)

Management of animals other than dogs, cats, and ferrets depends on the species, the circumstances of the bite, the epidemiology of rabies in the area, and the biting animal's history, current health status, and potential for exposure to rabies. The Zoonosis Branch, Epidemiology Division, Department of Public Health, should be consulted when circumstances warrant.

Wildlife

- Most wild mammals that bite or otherwise expose persons should be **considered** for euthanasia and rabies examination. All bites by such wildlife must be considered possible exposures to the rabies virus. Since the duration of clinical signs and the period of viral shedding are unknown for these species, an appropriate quarantine or isolation period

cannot be ascertained. Assessing rabies risk and the need for rabies diagnostic testing can be guided by the following:

- **Wild Carnivores:** Raccoons, skunks, and foxes are the terrestrial animals most often infected with rabies; therefore, any such animal that exposes a person should be euthanized at once (without unnecessary damage to the head) and the brain should be submitted for rabies testing.
- **Rodents and lagomorphs** (squirrels, rats, mice, hamsters, guinea pigs, gerbils, chipmunks, rabbits): are almost never found to be infected with rabies and have not been known to transmit rabies to humans. Bites by these animals are usually not considered a rabies risk and usually do not warrant rabies testing unless the animal is sick or behaving in an unusual manner. Rodents that **are** considered to be a rabies risk include woodchucks or groundhogs (*Marmota monax*) because they are frequently large enough to survive the attack of a rabid carnivore. For additional questions or guidance about whether to submit an animal for testing please contact the Alabama Department of Public Health.
- **Bats:** A bat that bites, scratches, or has any direct physical contact with a person should be safely captured (see page 41 for instructions), immediately euthanized, and the entire animal sent to the laboratory for rabies examination. People usually know when they have been bitten by a bat. However, because bats have small teeth that may leave marks that are not easily seen, there are situations in which rabies testing and medical advice should be sought even in the absence of an obvious bite wound. These include awakening to find a bat in the room, finding a bat in the room of an unattended child, having a bat physically brush against you, or finding a bat near a mentally impaired or intoxicated person. In these situations a bite cannot be definitively ruled out. If physical contact occurs or the situations above occur, and the bat is not available for testing (i.e., it escapes from the house, encounter occurs outdoors, etc.), an exposure could be considered possible and consultation with a physician is advised.
- **Other wild animals** (opossums, otters, polecats, beavers, weasels, etc.): In most situations involving non-reservoir species, the rabies risk is relatively low. The risk is higher and, consequently, rabies testing may be indicated if the animal is found in a rabies-endemic area, has opportunity for exposure to rabies reservoirs, is large enough to survive an attack by a rabid animal, or is ill or exhibiting abnormal behavior.

Rabies Testing

Rabies testing consists of examining the brain samples of animals microscopically to determine if the rabies virus is present. There are two ADPH Bureau of Clinical Laboratories (BCL) in the state that perform testing, located in Montgomery and Mobile. Specimens for testing should be dropped off at the local county health department (CHD). The CHD is responsible for forwarding the specimen to the appropriate ADPH BCL testing laboratory. A list of size and weight restrictions and packaging requirements is included in the following section, Rabies Specimen Acceptance. Routinely, most county health departments ship the specimens late in the day, but it is best to check with the local CHD to determine cut-off times for same day shipment.

For larger veterinary species, including cows and horses, specimens will need to be sent to Alabama Department of Agriculture and Industries (ADAI), Veterinary Diagnostic Laboratory for specimen preparation before being sent to the ADPH BCL testing laboratory. The CHD should be contacted before sending a sample to the Veterinary Diagnostic Laboratory to insure proper tracking and documentation is recorded.

Tissue Sample Collection and Handling for Rabies Testing

When an animal develops rabies, usually from the bite of another animal whose saliva is infected with the rabies virus, the virus moves trans-neuronally from the site of entry to the spinal cord and brain. Due to patterns of progression, a thorough histologic examination of the brain stem is critical to rabies diagnosis. Viral antigen is widespread in the brain of most animals positive for rabies, but because of the possibility of unilateral spreading of the virus, especially in larger animals, a negative finding for rabies can be made only if a complete cross-section of the brain stem is examined.

The complete brain of the animal should be submitted for testing. Although brain stem is the tissue most reliably found to contain viral antigen, the characteristic size and shape of the rabies virus that accumulates in the large neurons of foliar regions of the cerebellum are easily detected and recognized by direct fluorescent antibody (DFA) testing. Inclusion of this tissue yields a more confident diagnosis than examination of brain stem alone. Although the hippocampus was once the tissue of choice for histologic tests for Negri bodies, hippocampus is of limited additional value when brain stem and cerebellum are examined. If the cerebellum is missing from tissue submitted for rabies testing, however, a negative finding for rabies may be made from examination of brain stem and hippocampus. While a negative finding for rabies can be made only if brain stem tissue is among the tissues examined, incomplete specimens should be tested, if possible. Specific staining in any tissue reacted with anti-rabies antibody is diagnostic of rabies infection.

Virus is present in the saliva of an infected animal only after virus proliferation in the central nervous system and subsequent progression from the brain to the salivary glands. A negative DFA test for the presence of rabies virus in brain tissue assures that contact with saliva of a biting animal **could not** have transmitted rabies. Because virus may not be spread to all salivary glands and may be present only intermittently in saliva, negative tests of salivary glands or saliva cannot rule out rabies infection.

Shipment of Samples

Because rabies prophylaxis is usually delayed pending a laboratory report, specimen transit time to the laboratory should be as short as possible, preferably within 48 hours. A fresh, unfixed brain sample is critical to a rapid and accurate diagnosis of rabies. Refrigeration will preserve a sample for at least 48 hours. Freezing of the sample for transit will not reduce the sensitivity of the test, but may introduce additional testing delays and impede recognition and dissection of appropriate test samples. Repeated freeze-thaw cycles may reduce test sensitivity and should be avoided. Biocontainment during specimen transport is critical, to prevent both contamination of the outside of the package and cross-contamination between samples within the package.

Rabies Specimen Acceptance Criteria

1. Any mammal suspected of having rabies may be sent to the laboratory for examination. Unless circumstances suggest rabies infection, caged rodents such as hamsters, etc., should not be submitted for rabies testing. Specimens will be accepted from, and results reported to, any individual. Before submission, though, the state health department should be consulted. (See #6)
2. **NO LIVE ANIMALS WILL BE ACCEPTED UNDER ANY CIRCUMSTANCES.**
3. Specimen Preparation:
 - a. **DO NOT** club or shoot the animal in the head. The skull must remain intact.
 - b. **All larger animals must be decapitated before sending to the laboratory** (see attached notice). The Public Health laboratories prefer all animal heads to be removed prior to submission; however, both the Central Lab in Montgomery as well as the Mobile Division Laboratory will accept the entire bodies of small animals that are less than 20 inches in length and 15 pounds in weight.
 - c. Remove the head from the animal low enough to leave the salivary gland intact. **DO NOT DAMAGE THE BRAIN.**
 - d. Specimens should be placed under refrigerated conditions immediately. **NOTE:** Freezing is NOT recommended. Freezing should be used only in unavoidable delays. Frozen specimens delay testing. In addition, frozen and thawed tissue is considered not as satisfactory.
 - e. The specimen should be fresh. The test will not be performed if the brain tissue is decomposed or infested with maggots.
 - f. Spray specimens with an insecticide before submitting for rabies testing. Ticks and fleas are a problem for the analyst during autopsy.
 - g. **DO NOT** send specimens in formalin. The test cannot be performed on formalized tissues.
 - h. Place the head in a water-tight container, such as a clean paint can, and seal tightly. Place the container in a large water-tight container such as a Styrofoam ice chest and pack in enough wet ice or ice packs to last 24 hours. **THE SHIPPER IS RESPONSIBLE FOR MAKING SURE THE PACKAGE DOES NOT LEAK.** The outside of the package should be clearly labeled “Rabies Specimen.”
 - i. Every specimen must be accompanied by a completed “Rabies Testing Report Form” (Form BCL-264, an example of the form can be found under Forms in this Manual). All information requested must be supplied. These forms may be obtained through the county health department or the central and division laboratories. Please keep the report form dry and uncontaminated by placing it in a plastic bag and include it in the shipping container, but not in contact with the specimen itself. If shipping more than one specimen, ALL specimens must be

clearly identified or identifiable so there can be no mistake of which animal exposed which victim.

4. Notify your County Health Department Environmentalist that you have a specimen for rabies testing. He or she may be able to send the specimen for you. Otherwise, specimens should be delivered immediately to the State Health Laboratory nearest you or specimens may be accepted and shipped by commercial courier. **DO NOT send by U.S. Mail**

Montgomery Central Lab
8140 University Drive
Montgomery, AL 36130
Phone: 334-260-3400
Fax: 334-244-5083

Mobile Division Lab
757 Museum Drive
Mobile, AL 36608
Phone: 251-344-6049
Fax: 251-344-6895

5. Notify the laboratory in advance when and how the specimen is being sent and the expected time of arrival. If you are unable to reach the laboratory in your area, call the Montgomery Central Laboratory (334-260-3400).
6. All rabies reports will be telephoned and confirmed with a written report.

(Note: Results of test performed on weekends and holidays will be given to licensed physicians or emergency room personnel only.)

Specimens arriving at the laboratory by 11:00 am on weekdays will be reported on the same day. Otherwise, the report will go out the next scheduled workday. (Saturdays, Sundays, and holidays are not scheduled workdays.)

7. Rabies testing on weekends and holidays will be performed only in cases of high probability of human infection in which it is deemed that immediate test results are needed. The attending physician can request a test to be performed on Saturday, Sunday, or holidays by contacting the ADPH Epidemiology Division.
8. For questions regarding exposures, the need for post-exposure treatment, sources of rabies immunoglobulin, and human diploid cell vaccine contact the Alabama Department of Public Health, Epidemiology Division at 1-800-338-8374 (24 hour service).

Rabies Serology Testing for Humans

For humans, the rapid fluorescent focus inhibition test (RFFIT) is recommended by the Advisory Committee on Immunization Practices (ACIP). Serology via enzyme linked immunosorbent assay (ELISA) is **not** recommended. The RFFIT is the only valid method at this time to verify rabies virus neutralizing antibodies.

In CDC studies, all healthy persons tested 2–4 weeks after completion of pre-exposure and post-exposure rabies prophylaxis in accordance with ACIP guidelines demonstrated an adequate antibody response to rabies. Therefore, no testing of patients completing pre-exposure or post-exposure prophylaxis is necessary to document seroconversion unless the person is immunosuppressed. Patients who are immunosuppressed by disease or medications should postpone pre-exposure vaccinations and consider avoiding activities for which rabies pre-exposure prophylaxis is indicated. When that is not possible, immunosuppressed persons who are at risk for exposure to rabies should be vaccinated and their virus neutralizing antibody titers checked. In these cases, failures to seroconvert after the third dose should be managed in consultation with appropriate public health officials. When titers are obtained, specimens collected 1–2 weeks after pre-exposure or post-exposure prophylaxis should completely neutralize challenge virus at a 1:5 serum dilution by the RFFIT. Antibody titers might decline over time since the last vaccination. Small differences (i.e., within one dilution of sera) in the reported values of rabies virus neutralizing antibody titer (most properly reported according to a standard as IU/mL) might occur among laboratories that provide antibody determination using the recommended RFFIT. Rabies antibody titer determination tests that are not approved by FDA are not appropriate for use as a substitute for RFFIT in suspect human rabies ante-mortem testing because discrepant results between such tests and measures of actual virus neutralizing activity by RFFIT have been observed.

Although virus neutralizing antibody levels might not definitively determine a person's susceptibility or protection from a rabies virus exposure, titers in persons at risk for exposure are used to monitor the relative rabies immune status over time. To ensure the presence of a primed immune response over time among persons at higher than normal risk for exposure, titers should be checked periodically, with booster doses administered only as needed. Two years after primary pre-exposure vaccination, a complete neutralization of challenge virus at a dilution of 1:5 (by the RFFIT) was observed among 93%–98% of persons who received the 3-dose pre-exposure series intramuscularly and 83%–95% of persons who received the 3-dose series intradermally. If the titer falls below the minimum acceptable antibody level of complete neutralization at a serum dilution of 1:5, a single pre-exposure booster dose of vaccine is recommended for persons at continuous or frequent risk for exposure to rabies. The following guidelines are recommended for determining when serum testing should be performed after primary pre-exposure vaccination:

- A person in the continuous-risk category should have a serum sample tested for rabies virus neutralizing antibody every 6 months.

- A person in the frequent-risk category should have a serum sample tested for rabies virus neutralizing antibody every 2 years.

Laboratories Performing RFFIT

Before sending a specimen, please call the lab for submission instruction and forms.

Rabies Laboratory/RFFIT

Mosier Hall

Kansas State University

1800 Denison Avenue

Manhattan, KS 66506-5600

Phone: (785) 532-4483

Website: <http://www.vet.ksu.edu/depts/rabies/rffit.htm>

Email: rabies@vet.k-state.edu

Contact: Susan Montgomery

Atlanta Health Associates

309 Pirkle Ferry Road, Suite D300

Cumming, GA 30040

Phone: (770) 205-9091 or (800) 717-5612

Fax: (770) 204-9021

Website: <http://Atlantahealth.net>

Email: rnewhouse@atlantahealth.net

Contact: Mary Yager

Importation and Interstate Movement of Animals

International Importation

CDC regulates the importation of dogs and cats into the United States. Importers of dogs must comply with rabies vaccination requirements (42 CFR, Part 71.51 [c] [<http://www.cdc.gov/ncidod/dq/animal.html>]) and complete CDC Form 75.37 (http://www.cdc.gov/ncidod/dq/pdf/animal/dog_quarantine_notice_08-04-06-cdc7537.pdf). In Alabama, the State Veterinarian at the Alabama Department of Agriculture and Industries should be notified within 72 hours of the arrival of any imported dog required to be placed in confinement under the CDC regulation. Failure of the owner to comply with these confinement requirements should be promptly reported to the Division of Global Migration and Quarantine, CDC (telephone: 404-639-3441).

Federal regulations alone are insufficient to prevent the introduction of rabid animals into the United States. All imported dogs and cats are subject to state and local laws governing rabies and should be currently vaccinated against rabies in accordance with Section 3-7A-2 of the Code of Alabama 1975. Failure of the owner to comply with State or local requirements should be referred to the Alabama Department of Agriculture and Industries.

Interstate Transportation

Before interstate movement (including commonwealths and territories), dogs, cats, and ferrets, should be currently vaccinated against rabies in accordance with Section 3-7A-2 of the Code of Alabama 1975. Animals in transit should be accompanied by a currently valid Alabama Rabies Vaccination Certificate. (A copy of the form is found in the Forms section of this Manual, page 39.) When an interstate health certificate or certificate of veterinary inspection is required, it should contain the same rabies vaccination information as the Alabama Rabies Vaccination Certificate.

Importation of Non-Domesticated Animals into Alabama

According to the Prohibited Animal Regulation of Alabama (§220-3-.26 AL Dept. of Conservation and Natural Resources Administrative Code) no one:

“shall possess, sell, offer for sale, import, bring, or cause to be brought or imported in the State of Alabama...any member of the family Cerevidae (to include but not be limited to deer, elk, moose, caribou), species of coyote, species of fox, species of raccoon, species of skunk, wild rodent or strain of wild turkey, black bear (*Ursus Americanus*), mountain lion (*Felis concolor*), bobcat (*Felis rufus*), Pronghorn Antelope (*Antilocapridae*), any non-domestic member of the families *Suidae* (pigs), *Tayassuidae* (peccaries), or *Bovidae* (bison, mountain goat, mountain sheep).”

Areas with Dog-to-Dog Rabies Transmission

Canine rabies virus variants have been eliminated in the US. Rabid dogs have been introduced into the continental United States from areas with dog-to-dog rabies transmission. ADPH Zoonotic, Rabies Control and Bite Manual, July 2015

This practice poses the risk of introducing canine-transmitted rabies to areas where it does not currently exist. The movement of dogs for the purposes of adoption or sales from areas with dog-to-dog rabies transmission should be prohibited.

Rabies Control during a Disaster Response

Animals might be displaced during and after man-made or natural disasters and require emergency sheltering. Animal rabies vaccination and exposure histories often are not available for displaced animals. Disaster response creates situations where animal caretakers might lack appropriate training and pre-exposure vaccination. In such situations, it is critical to implement and coordinate rabies-prevention and –control measures to reduce the risk of rabies transmission and the need for human post-exposure prophylaxis. Such measures include:

1. Coordinate relief efforts of individuals and organizations with the local emergency operations center before deployment.
2. Adopt minimum standards for animal caretakers that include personal protective equipment, previous rabies vaccination, and appropriate training in animal handling.
3. Examine each animal at a triage site for signs of rabies.
4. Isolate animals exhibiting signs of rabies, pending evaluation by a veterinarian.
5. Ensure that all animals have a unique identifier.
6. Administer a rabies vaccination to all dogs, cats, and ferrets unless reliable proof of vaccination exists. This is especially important for dogs and cats housed in group settings. Personnel should be aware that rabies vaccines may take as long as 28 days to become effective.
7. Maintain documentation of animal disposition and location (i.e., returned to owner, died or euthanized, adopted, relocated to another shelter and address of new location).
8. Provide facilities to confine and observe animals involved in exposures.
9. Report human exposures to appropriate public health authorities

For more information on information on animal shelters in times of disaster, consult the CDC's Interim Guidelines for Animal Health and Control of Disease Transmission in Pet Shelters (<http://emergency.cdc.gov/disasters/animalhealthguidelines.asp>).

Alabama's primary agency in times of disaster for animal health is the Department of Agriculture and Industry, lead by the State Veterinarian and the Alabama State Agriculture Response Team (SART). For more information about Alabama's animal health disaster plans and protocols, consult Alabama's SART's website (<http://www.alsart.org>).

Frequently Asked Questions (FAQ) About Rabies

What is the incubation period of rabies in animals?

The incubation period is the time between exposure and onset of clinical signs of disease. The incubation period may vary depending on the species from a few days to several years, but typically lasts 1 to 3 months for domestic animals. Wildlife, such as bats and raccoons, may have incubation periods much longer, up to 6-12 months. This period is quite long because the rabies virus spreads slowly through the nerves to the spinal cord and brain. There are no signs of illness during the incubation period; rabies virus is not transmissible during this time. When the virus reaches the brain, it multiplies rapidly and passes to the salivary glands. At the point clinical symptoms of rabies become present and the rabies virus can be transmitted via saliva. For information on specific incubation times for different species, please see the appropriate chapter earlier in this manual.

How can I protect my pet from rabies?

First, take your pet to the veterinarian on a regular basis and keep rabies vaccinations up-to-date for all dogs, cats, and ferrets. This is a legal requirement in the State of Alabama. Second, keeping your pets under direct supervision will help prevent unknown exposures to the wild rabies-carrying wildlife population. Third, spay or neuter your pets to help reduce the number of unwanted pets that may not be properly cared for or vaccinated regularly.

Why does my pet need the rabies vaccine?

Your pets and other domestic animals can be infected when they are bitten by rabid wild animals. Animals represent a common link between humans and the rabies reservoirs. When rabies occurs in domestic animals, the risk to humans is increased. Therefore, pets are vaccinated to prevent them from acquiring the disease from wildlife, and possibly transmitting it to humans.

What happens if a neighborhood dog or cat bites me?

First, you should seek medical evaluation for any animal bite. In Alabama, potential exposures must be confirmed by a licensed physician before ADPH can issue quarantine orders. The county health department should be notified by you or your physician or in some cases by the local law enforcement agency that is involved. ADPH will then investigate the exposure and determine what actions need to be taken for you and the animal by written and verbal communication.

If the animal is owned, it can be quarantined for 10 days under the supervision of a licensed veterinarian. Research on the disease stages of rabies in dogs, cats, and ferrets has proven that if the animal is still alive at the end of 10 days and free from clinical signs of rabies, then the animal was not shedding the virus at the time of the exposure, thus eliminating the chance of exposure to rabies virus. If a dog, cat, or ferret appeared ill at the time it bit you or

becomes ill during the 10 day quarantine, it should be evaluated by a veterinarian for signs of rabies and you should seek medical advice about the need for rabies prophylaxis.

For more information on recommendations about biting incidences, quarantine, and post-exposure prophylaxis see: *Compendium of Animal Rabies Control, 2008* (CDC) and *Rabies Prevention – United States, 2008 Recommendations of the Immunization Practices Advisory Committee* (ACIP).

Can I get rabies in any way other than an animal bite?

Yes. Scratches, abrasions, open wounds, or mucous membranes contaminated with saliva or other potentially infectious material (such as brain tissue) from a rabid animal are considered potential exposures to rabies. If the touching of a suspected rabid animal results in contact with potentially infectious (wet) saliva or CNS tissue, consult with a physician to assess any potential exposure. It is very important that any possible exposures with a rabid animal be reported to the local or county health department by you, your physician, or the law enforcement agency that is involved. This is the first step in assessing the seriousness of an exposure and how to handle the situation. If the animal is owned, it can be quarantined for 10 days under the supervision of a licensed veterinarian. Research on the disease stages of rabies in dogs, cats, and ferrets has proven that if the animal is still alive at the end of 10 days and free from clinical signs of rabies, then the animal was not shedding the virus at the time of the exposure, thus, eliminating a chance of exposure to the rabies virus.

Inhalation of aerosolized rabies virus is also a potential non-bite route of exposure, but other than laboratory workers and spelunkers, most people are unlikely to encounter an aerosol of rabies virus. Other contact, such as petting a rabid animal or contact with the blood, urine, or feces (i.e., guano) of a rabid animal, does **not** constitute an exposure and is not an indication for prophylaxis. Contracting rabies from a non-bite exposure is dependent upon the virus living in an environment with ultraviolet light, outside of cells, and enduring at least some drying time. There are just too many variables to determine how long it could survive since it would be dependent on all of the environmental conditions in addition to the viral load. Non-bite exposures to rabies are very rare.

What medical attention do I need if I am exposed to rabies?

One of the most effective methods to decrease the chances for infection involves thorough washing of the wound with soap and water. Specific medical attention for someone exposed to rabies is called post-exposure prophylaxis or PEP. Post-exposure prophylaxis consists of a regimen of one dose of rabies immune globulin and five doses of rabies vaccine over a 28-day period. Rabies immunoglobulin and the first dose of rabies vaccine should be given by your health care provider concurrently when it has been determined to be indicated by a physician. Additional doses of rabies vaccine should be given on days 3, 7, 14, and 28 after the first vaccination. Current vaccines are relatively painless and are given in your arm, like a flu or

tetanus vaccine. For more information, please see Rabies Post-Exposure Vaccination for Humans section of the Manual on page 25.

How long do I have until I start the rabies post-exposure prophylaxis?

Rabies is considered a medical urgency, not a medical emergency. Always follow the guidance of your physician. Initiation of the shots depends on the animal that has exposed you possibly to rabies. Rabies vaccinations may be delayed depending on the species of animal and subsequent quarantine recommendations.

Where can I go to obtain the Rabies Vaccine?

The Alabama Department of Public Health (ADPH) does not routinely administer the rabies vaccine nor do they stockpile it. You should consult your physician or visit the local emergency room. ADPH will be available for consultation with your physician about the need to receive the vaccine, obtaining the vaccine, or its administration.

What should I do if I come in contact with a bat?

If you are bitten by a bat – or if infectious material (such as saliva) from a bat gets into your eyes, nose, mouth, or a wound – wash the affected area thoroughly and get medical attention immediately. Whenever possible, the bat should be captured and sent to a laboratory for rabies testing.

People usually know when they have been bitten by a bat. However, because bats have small teeth which may leave marks that are not easily seen, there are situations in which you should seek medical advice even in the absence of an obvious bite wound. For example, if you awaken and find a bat in your bedroom, see a bat in the room of an unattended child, or see a bat near a mentally impaired or intoxicated person seek medical advice and have the bat tested. People cannot get rabies just from seeing a bat in an attic, in a cave, or at a distance. In addition, people cannot get rabies from having contact with bat guano (feces), blood, urine, or from touching a bat on its fur (even though bats should never be handled).

What should I do if I find a bat in my home?

If you see a bat in your home and you are sure no human or pet exposure has occurred, confine the bat to a room by closing all doors and windows leading out of the room except those to the outside. The bat will probably leave soon. If not, it can be caught, as described below, and released outdoors away from people and pets.

However, if there is any question of exposure, leave the bat alone and call animal control or a wildlife conservation agency for assistance. If professional assistance is unavailable, use precautions to capture the bat safely, as described below.

What you will need:

Leather work gloves (put them on)

Small box or coffee can

Piece of cardboard

Tape

When the bat lands, approach it slowly and place a box or coffee can over it. Slide the cardboard under the container to trap the bat inside. Tape the cardboard to the container securely. First, contact your local veterinarian for euthanizing the bat. When correctly done, there will be no damage to the specimen needed for proper testing. Then contact your health department or animal control authority to make arrangements for rabies testing.

Should I be concerned about rabies when I travel outside the United States?

Yes. Rabies and rabies-like viruses can occur in animals anywhere in the world. In most countries, the risk of rabies in an encounter with an animal and the precautions necessary to prevent rabies are the same as they are in the United States. When traveling, it is always prudent to avoid approaching any wild or domestic animal.

The developing countries in Africa, Asia, and Latin America have additional problems in that dog rabies is common there and preventive treatment for human rabies may be difficult to obtain. The importance of rabid dogs in these countries, where tens of thousands of people die of the disease each year, cannot be overstated. Unlike programs in developed countries, dog rabies vaccination programs in developing countries have not always been successful. Before traveling abroad, consult a health care provider, travel clinic, or health department about your risk of exposure to rabies and how to handle an exposure should it occur.

Forms

Alabama Rabies Testing Submission Form

RABIES TEST REPORT
Bureau of Clinical Laboratories
Alabama Department of Public Health

SUBMITTING INSTRUCTIONS

- 1. Please notify the laboratory Monday through Friday prior to shipping a specimen as to how and when the specimen is being sent. However, special arrangements must be made to perform tests on weekends and holidays. These tests must be requested by a medical doctor licensed to practice in the State of Alabama or the State Public Health Veterinarian (See Montgomery Number).

Laboratory Office Phone Birmingham (205) 933-1388 Mobile (251) 344-6049 Montgomery (334) 260-3400

- 2. Remove the head from the animal low enough to leave the salivary glands intact. DO NOT damage the brain.
3. Place the head in a water-tight container, such as a clean paint can, and seal tightly. Place the container in a larger water-tight container such as a styrofoam ice chest, and pack in enough wet ice or polar packs to last 24 hours. The shipper is responsible for making sure the package does not leak.
4. Complete the "Submitter's Information" section of the "Rabies Test Report Form", place in an envelope and attach to the outside of the box in a manner that will not allow form to become damaged. Label the outside package clearly as "Rabies Specimen".
5. Take or ship specimen immediately to the State Health Laboratory nearest you. (See back of form.) Specimens may be shipped by most commercial couriers. (Corporate Express, some bus lines, etc.) DO NOT send by U.S. mail.

Note: If you are unable to reach the laboratory in your area, call Montgomery (334) 260-3400. This number is answered 24 hours a day.

SUBMITTER'S INFORMATION

1. Kind of animal: Dog Cat Bat Skunk Fox Raccoon Opossum Other:

2. Identifying characteristics: Breed, color, markings, etc.

3. Date animal died Date specimen submitted Animal vaccinated? Yes No Unknown

4. Who was exposed: Human Unknown Animal Type of exposure: Bite Handling Scratch Saliva

Name of party exposed: Phone:

5. Where incident occurred: City County Zip Code

6. RESPONSIBLE PARTY FOR LAB TO CONTACT (Weekend / Holiday requests must include a physician's name. (Positive rabies results are phoned to the name you list below as the submitter; please ensure that someone will be available to accept the test results.):

Submitter: Animal Control Individual Veterinarian Physician Other

Name: City: Phone:

7. Division Laboratory specimen submitted to: Birmingham Mobile Montgomery

8. Send report to: (Fill out completely)

Name: Phone:

Address:

City AL Zip Code



ADPH-BCL-264/REV 02/06

NASPHV Form 51

RABIES VACCINATION CERTIFICATE
 NASPHV FORM 51 (revised 2007)

Owner's Name & Address Print Clearly			RABIES TAG #		
LAST FIRST M.I.			MICROCHIP #		
NO. STREET			TELEPHONE #		
CITY STATE ZIP					
SPECIES Dog <input type="checkbox"/> Cat <input type="checkbox"/> Ferret <input type="checkbox"/> Other: <input type="checkbox"/> _____ <small>(specify)</small>	AGE ____ Months <input type="checkbox"/> ____ Years <input type="checkbox"/>	SIZE Under 20 lbs. <input type="checkbox"/> 20 - 50 lbs. <input type="checkbox"/> Over 50 lbs. <input type="checkbox"/>	PREDOMINANT BREED _____	PREDOMINANT COLORS/MARKINGS _____ _____	
	SEX <input type="checkbox"/> Male <input type="checkbox"/> Female <input type="checkbox"/> Neutered		ANIMAL NAME _____		
Animal Control License <input type="checkbox"/> 1 Yr <input type="checkbox"/> 3 Yr <input type="checkbox"/> Other _____					
DATE VACCINATED _____ Month / Day / Year	Product Name: _____ Manufacturer: _____ <small>(First 3 letters)</small> <input type="text"/> <input type="text"/> <input type="text"/>		Veterinarian's Name: _____		
NEXT VACCINATION DUE BY: _____ Month / Day / Year	<input type="checkbox"/> 1 Yr USDA Licensed Vaccine <input type="checkbox"/> 3 Yr USDA Licensed Vaccine <input type="checkbox"/> 4 Yr USDA Licensed Vaccine <input type="checkbox"/> Initial dose <input type="checkbox"/> Booster dose		License Number: _____		
	Vaccine Serial (lot) Number _____		Veterinarian's Signature Address: _____ _____ _____		

Alabama Rabies Vaccination Certificate

		ALABAMA STATE DEPARTMENT OF PUBLIC HEALTH							
THIS IS TO CERTIFY THAT:									
1.	Name	Species	Breed	Sex	Age	Color	Tag No.	<input type="checkbox"/> 1 yr	<input type="checkbox"/> 3 yr
2.	_____	_____	_____	_____	_____	_____	_____	<input type="checkbox"/> 1 yr	<input type="checkbox"/> 3 yr
3.	_____	_____	_____	_____	_____	_____	_____	<input type="checkbox"/> 1 yr	<input type="checkbox"/> 3 yr
4.	_____	_____	_____	_____	_____	_____	_____	<input type="checkbox"/> 1 yr	<input type="checkbox"/> 3 yr
HAS BEEN VACCINATED AGAINST RABIES ON _____ <small>Mo. Day Year</small>									
VACCINE MANUFACTURER _____ LOT NO. _____									
Owner's Name _____									
Address _____									
City _____ County _____ Zip _____									
TELEPHONE NO. _____									
								<small>Signed: Rabies Inspector or Authorized Agent Deliver Original to Owner, one copy to County Health Department, File 3rd copy.</small>	
<small>ADPH-A-29-rev.08.09.ch</small>									

Animal-Related Injury or Damage Contacts

Vaccine Manufacturers

Sanofi Pasteur 1-800-VACCINE
Novartis 1-877-683-4732

For Human Exposure Questions, Animal Exposure Questions:

Division of Epidemiology, Alabama Department of Public Health (ADPH)

State Public Health Veterinarian (334) 206-5969

24 hour Emergency Consultation (800) 338-8374

For Emergency Rabies Testing:

ADPH, Bureau of Clinical Laboratories (24 hour Service)

Montgomery (334) 260-3400

Mobile (251) 344-6049

Alabama Veterinary Diagnostic Laboratories

Auburn (24 hr. Service) (334) 844-4987

Elba (Mon – Fri 8-5) (334) 897-6340

Boaz (Mon – Fri 8-5) (256) 593-2995

Hanceville (Mon – Fri 8-5) (256) 352-8036

For Wildlife Injuries or Wildlife Questions:

Alabama Department of Conservation and Natural Resources, Wildlife Division

(Or a local Conservation Officer) (334) 242-3471

Alabama Wildlife Rescue Service (205) 663-7930

24 hr. Hotline (after hours) (205) 621-3333

For Illegal Wildlife Activities or Non-permitted Confinement:

Alabama Department of Conservation and Natural Resources, (334) 242-3467

Law Enforcement Div.

Emergencies (Report illegal hunting, poaching, etc.) (800) 272-4263

For Shipping Pets on Airlines:

ADPH Zoonotic, Rabies Control and Bite Manual, July 2015

Alabama State Veterinarian, Alabama Department of Agriculture and Industries
www.agi.state.al.us/state_veterinarian (334) 240-7253

USDA, Voice Response Service (800) 545-8732

For International Movement of Pets:

ASPCA, Education Department (212) 876-7700 x4412

(Order Booklet: "Traveling With Your Pet")

Call Consulate of country of destination for current requirements

For Animal Welfare Act Enforcement or Permits (i.e. Selling Animals commercially):

USDA, Animal Care (918) 855-7100

For Bat Abatement and other Wildlife Containment Questions:

USDA, Wildlife Services (334) 844-5670

For Abused or Neglected Animals: Contact local humane society or

Alabama Humane Federation (205) 755-9170

OTHER CONTACTS FOR ANIMAL-RELATED INJURIES OF DAMAGE:

Alabama Veterinary Medical Association (334) 395-0086

Alabama State Board of Veterinary Medical Examiners (256) 353-3544

Auburn University, College of Veterinary Medicine (334) 844-4546

Tuskegee University, School of Veterinary Medicine (334) 727-8174

National Animal Poison Control Center (fee charged for services) (800) 548-2423

Animal Blood Bank Hotline (24 hour service to veterinarians) (800) 243-5759

To report an animal bite/exposure, call the respective County Health Department Environmental Health Office listed on the ADPH website.

Currently FDA Licensed Rabies Vaccines

Part III: Rabies vaccines licensed and marketed in the United States, 2008

Product name	Produced by	License no.	Marketed by	For use in	Dosage (mL)	Age at primary vaccination*	Booster recommended	Route of inoculation
A) MONOVALENT (inactivated)								
RABVAC 1	Fort Dodge Animal Health	112	Fort Dodge Animal Health	Dogs	1	3 mos [†]	Annually	IM [§] or SC [¶]
				Cats	1	3 mos	Annually	IM or SC
RABVAC 3	Fort Dodge Animal Health	112	Fort Dodge Animal Health	Dogs	1	3 mos	1 year later and triennially	IM or SC
				Cats	1	3 mos	1 year later and triennially	IM or SC
				Horses	2	3 mos	Annually	IM
RABVAC 3 TF	Fort Dodge Animal Health	112	Fort Dodge Animal Health	Dogs	1	3 mos	1 year later and triennially	IM or SC
				Cats	1	3 mos	1 year later and triennially	IM or SC
				Horses	2	3 mos	Annually	IM
DEFENSOR 1	Pfizer, Inc.	189	Pfizer, Inc.	Dogs	1	3 mos	Annually	IM or SC
				Cats	1	3 mos	Annually	SC
DEFENSOR 3	Pfizer, Inc.	189	Pfizer, Inc.	Dogs	1	3 mos	1 year later and triennially	IM or SC
				Cats	1	3 mos	1 year later and triennially	SC
				Sheep	2	3 mos	Annually	IM
				Cattle	2	3 mos	Annually	IM
RABDOMUN	Pfizer, Inc.	189	Schering-Plough	Dogs	1	3 mos	1 year later and triennially	IM or SC
				Cats	1	3 mos	1 year later and triennially	SC
				Sheep	2	3 mos	Annually	IM
				Cattle	2	3 mos	Annually	IM
RABDOMUN 1	Pfizer, Inc.	189	Schering-Plough	Dogs	1	3 mos	Annually	IM or SC
				Cats	1	3 mos	Annually	SC
CONTINUUM RABIES	Intervet, Inc.	286	Intervet, Inc.	Dogs	1	3 mos	1 year later and triennially	SC
				Cats	1	3 mos	1 year later and quadrennially	SC
PRORAB-1	Intervet, Inc.	286	Intervet, Inc.	Dogs	1	3 mos	Annually	IM or SC
				Cats	1	3 mos	Annually	IM or SC
				Sheep	2	3 mos	Annually	IM
IMRAB 1	Merial, Inc.	298	Merial, Inc.	Dogs	1	3 mos	Annually	SC
				Cats	1	3 mos	Annually	SC
IMRAB 1 TF	Merial, Inc.	298	Merial, Inc.	Dogs	1	3 mos	Annually	SC
				Cats	1	3 mos	Annually	SC
IMRAB 3	Merial, Inc.	298	Merial, Inc.	Dogs	1	3 mos	1 year later and triennially	IM or SC
				Cats	1	3 mos	1 year later and triennially	IM or SC
				Sheep	2	3 mos	1 year later and triennially	IM or SC
				Cattle	2	3 mos	Annually	IM or SC
				Horses	2	3 mos	Annually	IM or SC
				Ferrets	1	3 mos	Annually	SC
IMRAB 3 TF	Merial, Inc.	298	Merial, Inc.	Dogs	1	3 mos	1 year later and triennially	IM or SC
				Cats	1	3 mos	1 year later and triennially	IM or SC
				Ferrets	1	3 mos	Annually	SC
IMRAB Large Animal	Merial, Inc.	298	Merial, Inc.	Cattle	2	3 mos	Annually	IM or SC
				Horses	2	3 mos	Annually	IM or SC
				Sheep	2	3 mos	1 year later and triennially	IM or SC
B) MONOVALENT (Rabies glycoprotein, live canary pox vector)								
PUREVAX Feline Rabies	Merial, Inc.	298	Merial, Inc.	Cats	1	8 wks	Annually	SC
C) COMBINATION (Inactivated rabies)								
CONTINUUM DAP-R	Intervet, Inc.	286	Intervet, Inc.	Dogs	1	3 mos	1 year later and triennially	SC
CONTINUUM Feline HCP-R	Intervet, Inc.	286	Intervet, Inc.	Cats	1	3 mos	1 year later and quadrennially**	SC
Equine POTOMAVAC + IMRAB	Merial, Inc.	298	Merial, Inc.	Horses	1	3 mos	Annually	IM
D) COMBINATION (Rabies glycoprotein, live canary pox vector)								
PUREVAX Feline 3/Rabies	Merial, Inc.	298	Merial, Inc.	Cats	1	8 wks	Annually	SC
PUREVAX Feline 4/Rabies	Merial, Inc.	298	Merial, Inc.	Cats	1	8 wks	Annually	SC
E) ORAL (Rabies glycoprotein, live vaccinia vector) — RESTRICTED TO USE IN STATE AND FEDERAL RABIES-CONTROL PROGRAMS								
RABORAL V-RG	Merial, Inc.	298	Merial, Inc.	Coyotes	N/A††	N/A	As determined by local authorities	Oral
				Raccoons				

* Minimum age (or older) and revaccinated 1 year later.

† One month = 28 days.

§ Intramuscularly.

¶ Subcutaneously.

** Nonrabies fractions have a 3-year duration (see label).

†† Not applicable.

Rabies vaccine manufacturer contact information

Manufacturer	Phone number	Internet address
Fort Dodge Animal Health	800-533-8536	http://www.wyeth.com/divisions/fort_dodge.asp
Intervet, Inc.	800-835-0541	http://www.intervetusa.com
Merial, Inc.	888-637-4251	http://us.merial.com
Pfizer, Inc.	800-366-5288	http://www.pfizerah.com
Schering-Plough Animal Health	800-521-5767	http://www.spah.com/usa

Note: ADVERSE EVENTS: Adverse events should be reported to the vaccine manufacturer and to U.S. Department of Agriculture, Animal and Plant Health Inspection Service, Center for Veterinary Biologics (Internet: http://www.aphis.usda.gov/animal_health/vet_biologics/vb_adverse_event.shtml); telephone: 800-752-6255; or e-mail: cvb@usda.gov).

Alabama Positive Cases of Rabies 1950 - 2012

YEAR	Alpaca	Bat	Bobcat	Cat	Chipmunk	Cow	Coyote	Dog	Fox	Goat	Horse	Human	Llama	Mink	Mule	Opossum	Pig	Raccoon	Skunk	Squirrel	Weasel	Total
1950				8		43		152	120								2					325
1951				9		17		263	63	1		2					2					357
1952				19		46		400	69	1												535
1953				18		37		511	160	1	2	1					2					732
1954				14		28		307	106			1					1	1				458
1955				14		27		209	93	1							1		1			346
1956				8		19		268	91													386
1957				14	1			193	33	1								1	1			244
1958				3		3		202	15													223
1959				7		23		193	45			1					1					270
1960				3		9		66	11		1								1			91
1961		2		3		3		39	16									1	1			65
1962				3		2		18	5		1				1					1		31
1963		1		3		3		5	22			1							1			36
1964				1		2		5	24		1								3			36
1965		2		1				2	12										1			18
1966		3			1	1		4	8										5			22
1967		3		2		6		4	26										10	1		52
1968		2				3		2	19										3			29
1969		1		1		5		6	42										3			58
1970		6		2		4		7	29									1				49
1971		4				6		2	47	1								2	1			63
1972		1				4		6	60									5	6			82
1973		2		2		4		4	28									1	10			51
1974		3		2	1	4		3	12									4	19			48
1975		4		2				2	10									4	12			34
1976		5						3	1									6	3			18
1977		2						1	1									5	3		1	13
1978		4		4		1		5						1				30	6	1	1	53
1979		14		1				3	5		1							37	12			73
1980		8		3				1	2									23	19			56
1981		33		4				4	3									52	27			123
1982		66		3		1		2	3									47	24			146
1983		30				1		2	1									42	9			85
1984		38		3				1	1									42	13			98
1985		35		3				3	2	1	2							108	6			160
1986		45		3				2	8							1		53	5			117
1987		21		1					1									51	3			77
1988		19	1	1				2	3									68	1			95
1989		19		7				5	8									78		2		119
1990		9		9				7	7							1		57	2	1		93
1991		15		3			1	3	6									50	1			79
1992		17		4		2		5	11									49	3			91
1993		25		3				2	6									76	4			116
1994		28		2				3	10			1						84	1	10		129
1995		40	1	3		1	1	1	7				1					90	5			150
1996		22		1				1	9	1	1							56	2			93
1997		29		2					11		1							41	3			87
1998		8						3	17		1							69	4			102
1999		23	1	3				2	14									81				124
2000		20		2		1		1	4									51				79
2001		31		3				3	6									22	1			66
2002		37	1	5				1	9									21	2			76
2003		26		3					3		1						1	32				66
2004		23	1	3				2	1									34				64
2005		21		1				2	11		2							41				78
2006		17		2					8									57				84
2007		20						1	11							1		47				80
2008		17	1	1			2	1	11		1							51				85
2009		22		3			1	1	12									41				80
2010		11		1			2	1	11									43	1			70
2011	1	18	3	1			2		11							1		46				83
2012		10		4		1		4	2									34				55
2013		7		2				2	1									27				39
2014		16	1	1			1	2	8		1							45	1			76
Total	1	885	10	234	3	307	10	2955	1412	8	16	7	1	1	1	5	9	###	239	6	2	8019

Alabama Positive Rabies Cases, 1950-2007

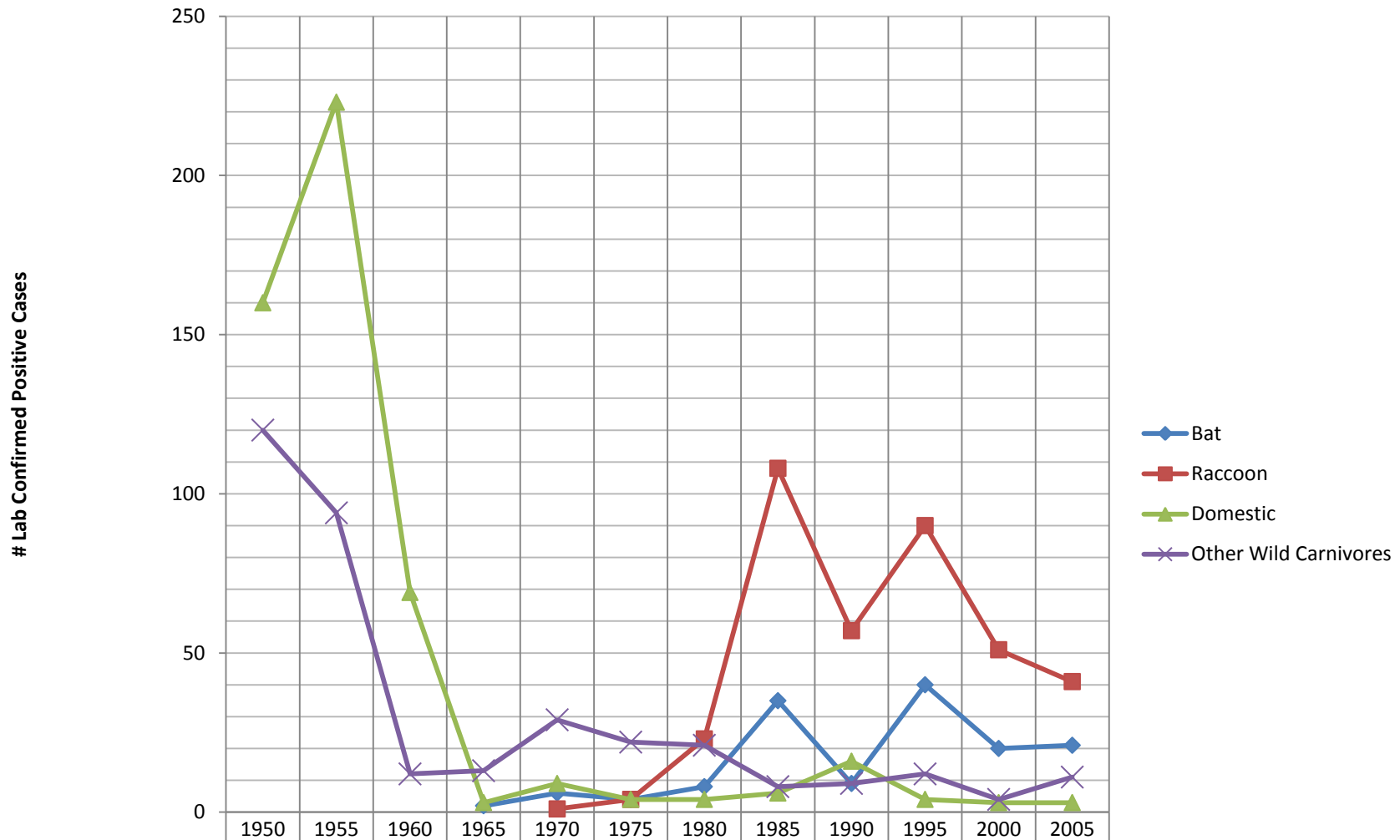

	1950	1955	1960	1965	1970	1975	1980	1985	1990	1995	2000	2005
Bat				2	6	4	8	35	9	40	20	21
Raccoon					1	4	23	108	57	90	51	41
Domestic	160	223	69	3	9	4	4	6	16	4	3	3
Other Wild Carnivores	120	94	12	13	29	22	21	8	9	12	4	11

1 SB469

2
3
4 ENROLLED, An Act,

5 Relating to rabies immunization of cats and dogs; to
6 amend Sections 3-7A-1, 3-7A-2, 3-7A-3, 3-7A-5, 3-7A-7, 3-7A-8,
7 3-7A-9, 3-7A-10, 3-7A-11, 3-7A-12, and 3-7A-14, Code of
8 Alabama 1975, to add members of the ferret (*Mustela putorius*
9 *furo*) family to the list of animals required to be vaccinated
10 against rabies; to provide further for public rabies clinics
11 and set fees therefor; to provide further for penalties to
12 owners of animals found to be unvaccinated; to allow for home
13 quarantine as directed by the health officer; to provide for
14 humane euthanizing of certain biting animals; to provide for
15 quarantine of rabies endemic areas; to authorize exemptions
16 from vaccinations under certain conditions; to add Section
17 3-7A-16 to the Code of Alabama 1975, to provide that persons
18 assisting at rabies vaccination clinics would be considered
19 volunteers; and in connection therewith would have as its
20 purpose or effect the requirement of a new or increased
21 expenditure of local funds within the meaning of Amendment 621
22 of the Constitution of Alabama of 1901, now appearing as
23 Section 111.05 of the Official ReCompilation of the
24 Constitution of Alabama of 1901, as amended.

25 BE IT ENACTED BY THE LEGISLATURE OF ALABAMA:

1 Section 1. Sections 3-7A-1, 3-7A-2, 3-7A-3, 3-7A-5,
2 3-7A-7, 3-7A-8, 3-7A-9, 3-7A-10, 3-7A-11, 3-7A-12, and
3 3-7A-14, Code of Alabama 1975, are amended to read as follows:

4 "§3-7A-1.

5 "As used in this chapter, the following words and
6 phrases shall have the following meanings respectively
7 ascribed to them unless the context clearly indicates
8 otherwise:

9 "(1) CANINE CORPS DOGS. Those members of the canine
10 family maintained by governmental agencies for exclusive use
11 in official duties assigned to those agencies. Seeing eye dogs
12 shall be included within the meaning of this definition.

13 "(2) CAT. All members of the domesticated feline
14 (*Felis catus*) family.

15 "(3) DOG. All members of the domesticated canine
16 (*Canis familiaris*) family.

17 "(4) FERRET. All members of the ferret (*Mustela*
18 *putorius furo*) family.

19 "(5) HAS BEEN EXPOSED. Suspected or confirmed
20 contact of saliva with a break or abrasion of the skin or with
21 any mucous membrane, as determined by the health officer or
22 medical or law enforcement personnel.

23 "(6) HEALTH OFFICER. The State Health Officer or any
24 county health officer as defined in Section 22-3-2, or his or
25 her designee.

1 "(7) IMMUNIZATION AGAINST RABIES. The injection, in
2 a manner approved by the State Health Officer and the State
3 Veterinarian, of rabies vaccine approved by the State Health
4 Officer and the State Veterinarian. The administration of
5 rabies vaccine to species other than those for which reliable
6 immunization data is available shall be a violation of this
7 chapter.

8 "(8) IMPOUNDING OFFICER. An agent of a county or
9 municipality vested with impounding authority for animals
10 covered under this chapter.

11 "(9) OWNER. Any person having a right of property in
12 a dog, cat, ferret, or other animal, or who keeps or harbors
13 the animal, or who has it in his or her care, or acts as its
14 custodian, or who permits the animal to remain on or about any
15 premises occupied by him or her.

16 "(10) PERSON. Individuals, firms, partnerships, and
17 associations.

18 "(11) QUARANTINE FOR RABIES OBSERVATION. Confinement
19 under the direct care, custody, control, and supervision of a
20 licensed veterinarian for a period of 10 days subsequent to
21 the date of the exposure, or as otherwise directed by the
22 appropriate health officer.

23 "(12) RABIES OFFICER. A licensed veterinarian as
24 defined in Section 34-29-61, duly appointed by the county

1 board of health and approved by the State Health Officer and
2 State Veterinarian.

3 "§3-7A-2.

4 "(a) Every owner of a dog, cat, or ferret required
5 to be immunized for rabies as defined in this chapter, shall
6 cause the animal to be immunized by the rabies officer, his or
7 her authorized representative, or any duly licensed
8 veterinarian, when the animal reaches three months of age and
9 subsequently in accordance with the intervals specified in the
10 vaccine's license. Notwithstanding the above, the State Board
11 of Health may establish by rule vaccine intervals or specific
12 vaccines, or both, to be used in public rabies vaccination
13 clinics, based on considerations such as county specific
14 prevalence of animal rabies or risk of animal rabies and the
15 vaccination rates of dogs, cats, and ferrets in a county.
16 Evidence of immunization shall consist of a printed
17 certificate furnished by the Alabama Department of Public
18 Health, upon which shall be legibly inscribed: a description
19 of the animal; its age, color, sex, breed, and tattoo
20 identification, if any; the name and address of the owner; the
21 lot number and type of vaccine used (modified live virus,
22 inactivated virus); the name of the manufacturer, the amount
23 of vaccine injected, and the date after which the animal is no
24 longer considered vaccinated; and a serially numbered tag
25 bearing the same number and year as that of the certificate.

1 The certificate shall be dated and signed by the person
2 authorized to administer the vaccine. Certificates not
3 complying with the provisions of this section, or certificates
4 issued by those persons unauthorized to administer rabies
5 vaccine, shall not be valid. In lieu of printed certificates,
6 licensed veterinarians may elect to utilize electronically
7 generated and maintained certificates if the certificates
8 contain substantially the same information as required above.
9 A signed paper copy of the certificate prescribed herein shall
10 be delivered to the owner of the animal immunized. A paper
11 copy or electronic copy or evidence thereof shall be
12 maintained by the licensed veterinarian for a period of one
13 year past the expiration date of a certificate. An additional
14 paper copy or electronic copy or listing shall be provided to
15 the local rabies enforcement authority upon request by the
16 authority and in the manner as so requested.

17 "(b) It shall be unlawful and in violation of the
18 provisions of this chapter for any person to import, receive,
19 sell, offer for sale, barter, or exchange animal rabies
20 vaccine, other than antirabies vaccine intended for human use,
21 to anyone except a duly licensed veterinarian.

22 "(c) (1) Notwithstanding the other provisions of this
23 chapter, the State Board of Health by rule may establish
24 procedures and qualifications for an exemption from the

1 requirement for a vaccination for an animal if a rabies
2 vaccination would be injurious to the animal's health.

3 "(2) An animal exempted under subdivision (1) shall
4 be considered unvaccinated by the State Board of Health in the
5 event of the animal's exposure to a confirmed or suspected
6 rabid animal.

7 "§3-7A-3.

8 "At public rabies clinics, the rabies officer may
9 charge an immunization fee established by a committee
10 consisting of the State Health Officer, the State
11 Veterinarian, and the president of the Alabama Veterinary
12 Medical Association, and approved by the State Board of Health
13 prior to the first day of January each year. The committee
14 shall consider all cost factors in administering the vaccine
15 as the economy dictates, including but not limited to the
16 current prices of vaccines.

17 "§3-7A-5.

18 "In the event a tag or certificate is lost after it
19 has been legally issued, every replacement thereof shall be
20 upon such terms as may be agreed upon with the rabies officer
21 or veterinarian by whom the animal has been immunized. In that
22 instance, a new certificate marked "duplicate" may be issued
23 and distributed according to Section 3-7A-2.

24 "§3-7A-7.

1 "Each county in the state shall provide a suitable
2 county pound and impounding officer for the impoundment of
3 dogs, cats, and ferrets found running at large in violation of
4 the provisions of this chapter. Every municipality with a
5 population over 5,000 in which the county pound is not located
6 shall maintain a suitable pound or contribute their pro rata
7 share to the staffing and upkeep of the county pound. If the
8 owner of an impounded animal is known, the owner shall be
9 given direct notice of the impoundment.

10 "§3-7A-8.

11 "All dogs, cats, and ferrets which have been
12 impounded in accordance with the provisions of this chapter,
13 after notice is given to the owner as provided in Section
14 3-7A-7, may be humanely destroyed and disposed of when not
15 redeemed by the owner within seven days. In case the owner of
16 an impounded animal desires to redeem the animal, he or she
17 may do so on the following condition: He or she shall pay for
18 the immunization of the animal and a penalty equal to the
19 minimum fine established in Section 3-7A-6 if a certificate of
20 current immunization cannot be produced, and for the board of
21 the animal for the period for which it was impounded. The
22 amount paid for the board of the animal shall accrue to the
23 credit of the city or county, depending upon the jurisdiction
24 of the pound in which the animal was confined. At his or her
25 discretion, the impounding officer may provide for adoption of

1 any animal not redeemed or claimed or otherwise disposed of,
2 to any person desiring the animal, if the person complies with
3 all the provisions of this chapter.

4 "§3-7A-9.

5 "(a) Whenever the rabies officer or the health
6 officer receives information that a human being has been
7 bitten or exposed by a dog, cat, or ferret required by this
8 chapter to be immunized against rabies, the officer or his or
9 her authorized agent shall cause the dog, cat, or ferret to be
10 placed in quarantine under the direct supervision of a duly
11 licensed veterinarian for rabies observation as prescribed in
12 Section 3-7A-1. It shall be unlawful for any person having
13 knowledge that a human being has been bitten or exposed by a
14 dog, cat, or ferret to fail to notify one or more of the
15 aforementioned officers. Vaccinated dogs, cats, and ferrets
16 may be authorized to be quarantined in the home of the owner
17 of the animal by the appropriate health officer.

18 "(b) When a dog, cat, or ferret has no owner as
19 determined by the rabies officer or the health officer after
20 reasonable investigation, or if the owner of a dog, cat, or
21 ferret agrees in writing, or if ordered by the health officer,
22 the animal shall be humanely destroyed immediately after the
23 exposure and the head shall be submitted for rabies
24 examination to the state health department laboratory.

1 "(c) The period of quarantine for animals other than
2 domesticated dogs, cats, and ferrets which have bitten or
3 exposed a human being shall be determined by the Alabama
4 Department of Public Health upon consultation with the U.S.
5 Public Health Service. If reliable epidemiologic data is
6 lacking for an animal species regarding duration of rabies
7 virus secretion from the salivary glands, the animals shall be
8 humanely destroyed and the head submitted for rabies
9 examination to the state health department laboratory.

10 "(d) It shall be a violation of this chapter for the
11 owner of such an animal to refuse to comply with the lawful
12 order of the health officer in any particular case. It is
13 unlawful for the owner to sell, give away, transfer to another
14 location, or otherwise dispose of any animal that is known to
15 have bitten or exposed a human being until it is released from
16 quarantine by the rabies officer, duly licensed veterinarian,
17 or by the appropriate health officer.

18 "(e) Instructions for the quarantine of the
19 offending animal shall be delivered in person or by telephone
20 or facsimile to the owner by the health officer or his or her
21 authorized agent. If the instructions cannot be delivered in
22 such a manner, they shall be mailed by regular mail, postage
23 prepaid and addressed to the owner of the animal. The
24 affidavit or testimony of the health officer or his or her
25 authorized agent, who delivers or mails the instructions,

1 shall be prima facie evidence of the receipt of such
2 instructions by the owner of the animal. Any expenses incurred
3 in the quarantine of the offending animal under this section
4 and Section 3-7A-8 shall be borne by the owner.

5 "(f) The veterinarian under whose care the offending
6 animal has been committed for quarantine shall promptly report
7 the results of his or her observation of the animal to the
8 attending physician of the human being bitten or exposed and
9 the appropriate health officer.

10 "(g) Canine corps dogs and seeing eye dogs shall be
11 exempt from the quarantine period if the exposure occurs in
12 the line of duty and evidence of proper immunization against
13 rabies is presented, but shall be examined immediately at the
14 end of 10 days by a licensed veterinarian, who shall report
15 the results of his or her examination to the appropriate
16 health officer as previously authorized.

17 "§3-7A-10.

18 "Those domesticated species, for which rabies
19 vaccine is recognized and recommended, upon exposure or
20 potential exposure to a known rabid animal, shall be humanely
21 destroyed or slaughtered immediately. Provided, however, the
22 owner has the option of quarantining the animal or animals
23 based on the recommendations of the Alabama Department of
24 Public Health upon consultation with the U.S. Public Health
25 Service.

1 "§3-7A-11.

2 "(a) The county board of health shall nominate
3 annually one duly licensed veterinarian from each county
4 within the state for the position of rabies officer.
5 Applications for this position may be received from any duly
6 licensed veterinarian residing within the county, or in the
7 event that no applications are received, from the Alabama
8 Veterinary Medical Association. Applications shall be provided
9 to the chair of each county board of health during the month
10 of November. The county board of health, not later than
11 January 31 of the appointing year, shall select and appoint a
12 nominee, subject to the approval of the State Health Officer
13 and the State Veterinarian. The appointee's term of office
14 shall expire on December 31 of the year of appointment;
15 provided, however, that he or she shall be eligible for
16 reappointment. The rabies officer may be removed from office,
17 for cause, by the county board of health or the State Health
18 Officer.

19 "(b) Appointments not made within the prescribed
20 time limits specified in this section shall become the joint
21 prerogative of the State Health Officer and the State
22 Veterinarian after due consultation with the appropriate
23 health officer.

24 "(c) For the purpose of providing proper enforcement
25 of this chapter, the county board of health is hereby invested

1 with general supervisory and administrative authority for the
2 implementation of this chapter. It shall be the duty of the
3 rabies officer to immunize for rabies all dogs, cats, and
4 ferrets covered under this chapter and he or she may employ as
5 many licensed veterinarians to serve as deputies to aid him or
6 her as he or she may desire. The rabies officer and his or her
7 deputies in each county are clothed with limited police powers
8 to the extent that they may issue citations for violations of
9 this chapter as an agent of the county board of health, and
10 shall not be subject to the limitations of Section 36- 21-50.
11 The sheriff and his deputies in each county and the police
12 officers in each incorporated municipality shall be aides, and
13 are hereby instructed to cooperate with the rabies officer in
14 carrying out the provisions of this chapter. The compensation
15 of the rabies officer and his or her deputies shall be limited
16 to the fees collected from enforcement of this chapter.

17 "§3-7A-12.

18 "Except as provided for in Section 3-7A-6, any
19 person violating or aiding or abetting the violation of any
20 provision of this chapter, or counterfeiting or forging any
21 certificate, or making any misrepresentation in regard to any
22 matter prescribed by this chapter or rule promulgated
23 hereunder or except as otherwise provided, or resisting,
24 obstructing, or impeding any authorized officer in enforcing
25 the provisions of this chapter, or refusing to produce for

1 immunization any animal in his or her possession for which
2 rabies vaccine is recognized and recommended, or for failing
3 to report an animal bite, shall be charged with a Class C
4 misdemeanor, and for the purpose of enforcing this chapter,
5 resort may be had to any court of competent jurisdiction.

6 §3-7A-14.

7 "Nothing in this chapter shall be held to limit in
8 any manner the power of any municipality to prohibit dogs,
9 cats, or ferrets from running at large, regardless of rabies
10 immunization status as herein provided; nor shall anything in
11 this chapter be construed, in any manner, to limit the power
12 of any municipality to further control and regulate dogs or
13 cats in such municipality."

14 Section 2. Section 3-7A-16 is added to the Code of
15 Alabama 1975, to read as follows:

16 §3-7A-16.

17 A licensed veterinarian and his or her assistants,
18 whether compensated by fee or otherwise or not compensated,
19 when assisting the county rabies officer at any officially
20 designated rabies vaccination clinic shall be considered a
21 volunteer for the purpose of Section 6-5-336.

22 Section 3. All laws or parts of laws which conflict
23 with this act are repealed.

1 Section 4. This act shall become effective on the
2 first day of the third month following its passage and
3 approval by the Governor, or its otherwise becoming law.

**RULES
OF
THE ALABAMA STATE BOARD OF HEALTH
BUREAU OF COMMUNICABLE DISEASES
CHAPTER 420-4-4
RABIES CONTROL PROGRAM**

420-4-4-.01	Definitions
420-4-4-.02	Nuisance Menacing Public Health
420-4-4-.03	Reporting of Exposures
420-4-4-.04	Investigation of Reports of Exposures
420-4-4-.05	Exceptions to Veterinary Confinement and Quarantine
420-4-4-.06	Rabies Vaccine Requirements
420-4-4-.07	Evidence of Immunization
420-4-4-.08	Exemptions from Vaccination
420-4-4-.09	Extra-Label Use of Animal Rabies Vaccines
420-4-4-.10	Adoption of National Compendium
Appendix A	Certificate of Exception From Rabies Vaccine

420-4-4-.01 **Definitions.**

- (1) “Animal” means any non-human mammal of the Kingdom *Animalia*.
- (2) “Cat” means all members of the domesticated feline (*Felis catus*) family.
- (3) “Dog” means all members of the domesticated canine (*Canis familiaris*) family.
- (4) “Ferret” means all members of the ferret (*Mustela putorius furo*) family.
- (5) “Department” means the Alabama Department of Public Health.

(6) “Domestic animal” means animals which, through association with people, have been bred to a degree which has resulted in genetic changes affecting the temperament, color, conformation, or other attributes of the species to an extent that make them unique and distinguishable from wild animals of their species.

(7) “Exposure” or “Exposes” means an incident resulting in contact of saliva or neural tissue with a break or abrasion of the skin or with any mucous membrane. The term includes a bite or scratch.

(8) “Extra-label use of vaccine” means the use of an animal vaccine in a species that is not specified on the product label or product insert.

(9) “Health Officer” means the State Health Officer or any county health officer as defined in §22-3-2, *Ala. Code 1975*, or his or her designee.

(10) “Hybrid cross” means an animal resulting from the crossbreeding between two different species or types of animals. Crosses between wild animal species and domestic animals are considered to be wild animals.

(11) “NASPHV” means the National Association of State Public Health Veterinarians, Inc.

(12) “Wildlife” means native or exotic animals normally living in the wild, other than those defined as domestic, including mammals, birds, reptiles, amphibians, and fresh water fish.

Author: William B. Johnston, D.V.M.; Dee Jones, D.V.M.

Statutory Authority: §§3-7A-1, et seq., *Ala. Code 1975*; §22-2-2(6), *Ala. Code 1975*

History: New Rule: September 19, 1997; Effective October 24, 1997; Operative November 4, 1997. **Repeal and Replace:** Filed November 19, 2009; Effective December 24, 2009.

420-4-4-.02 Nuisance Menacing Public Health. All unvaccinated dogs, cats and ferrets of any age that have exposed humans are declared to be nuisances menacing public health.

Author: William B. Johnston, D.V.M.; Dee Jones, D.V.M.

Statutory Authority: §§3-7A-1, et seq., *Ala. Code 1975*; §22-2-2(6), *Ala. Code 1975*; §22-10-1(5), *Ala. Code 1975*.

History: New Rule: Filed September 19, 1997; Effective October 24, 1997; Operative November 4, 1997.

Repeal and Replace: Filed November 19, 2009; Effective December 24, 2009.

420-4-4-.03 Reporting of Exposures. Suspected exposures to humans by animals capable of transmitting the rabies virus shall be reported to the county health department.

(a) Who Shall Report. The following individuals shall report exposures:

1. Health care professionals who treat persons with suspected exposures.
2. Veterinarians who have knowledge of suspected exposures.
3. Law enforcement personnel, including animal control officials, who have been informed of or who have investigated suspected exposures.
4. Any person having knowledge that a human has been exposed.

(b) What Shall be Reported. Suspected exposures by an animal to a human shall be reported to the county health department.

(c) When and How to Report. Suspected exposures must be reported to the county health department within 48 hours of the exposure. Reports may be given by written notice, telephone, or any reliable telecommunication system (e.g., facsimile, email).

Author: William B. Johnston, D.V.M.; Dee Jones, D.V.M.

Statutory Authority: §§3-7A-1, et seq., *Ala. Code 1975*; §22-2-2(6), *Ala. Code 1975*

History: New Rule: Filed September 19, 1997; Effective October 24, 1997; Operative November 4, 1997.

Repeal and Replace: Filed November 19, 2009; Effective December 24, 2009.

420-4-4-.04 Investigation of Reports of Exposures.

(1) Initiation of Investigation. When the county health department receives a report from health care professionals, law enforcement personnel, or other persons concerning a possible animal exposure to a human, an investigation shall promptly be conducted.

(2) Investigation Report. Information from the investigation shall be recorded by the environmental staff of the county health department. Reports shall remain on file in the county health department for a minimum of three years.

(3) Quarantine Orders. Quarantine orders resulting from an investigation may be issued by the Health Officer upon the confirmation of an exposure by a health care professional. Such orders may include home quarantine pursuant to Rule 420-4-4-.07.

Author: William B. Johnston, D.V.M.; Dee Jones, D.V.M.

Statutory Authority: §§3-7A-1, et seq., *Ala. Code 1975*; §22-2-2(6), *Ala. Code 1975*

History: New Rule: Filed September 19, 1997; Effective October 24, 1997; Operative November 4, 1997.

Repeal and Replace: Filed November 19, 2009; Effective December 24, 2009.

420-4-4-.05 Exceptions to Veterinary Confinement and Quarantine.

(1) Assistance Animals. Guide, hearing, and service dogs shall be exempt from the quarantine period specified in §3-7A-1(10), *Ala. Code 1975*, if exposures occur in the line of duty and evidence of immunization against rabies is presented. An assistance animal shall be examined by a licensed veterinarian 10 days after it exposes a human. Extended observation periods or additional testing may be required depending upon the animal's species, health status, circumstances of the exposure, and epidemiology of rabies in the area.

(2) Canine Corps Dogs. Canine corps dogs shall be exempt from the quarantine period specified in §3-7A-1(10), *Ala. Code 1975*, if exposures occur in the line of duty and evidence of immunization against rabies is presented. A canine corps dog shall be examined by a licensed veterinarian 10 days after it exposes a human.

(3) Home quarantine may be permitted at the discretion of the Health Officer only if all of the following conditions are met:

(a) The exposure was as a result of a provoked incident. A provoked incident occurs when a person creates a situation such that an expected reaction of the animal is to bite or attack (e.g., feeding, grabbing, threatening, etc.). An unprovoked incident occurs when an animal bites or attacks for no apparent reason.

(b) The animal is currently vaccinated against rabies.

(c) The owner or person responsible for the animal agrees to have the animal examined by a licensed veterinarian 10 days following the exposure.

(d) The animal is kept in an enclosed area (e.g., house, pen) in a designated confinement area (e.g., one room of house, one run isolated at a kennel facility) to avoid interaction with people and animals other than a single caretaker.

(e) If during the period of home quarantine the animal dies or exhibits clinical signs suggestive of rabies as determined by a licensed veterinarian, the owner or person responsible for the animal shall immediately contact the county health department. The Health Officer shall notify the person exposed and his/her physician so the physician can determine if post-exposure treatment is indicated.

(f) The owner is responsible for securing the animal during the period of home quarantine. Should the animal expose a human or animal and/or if the animal escapes or disappears from home quarantine, the owner or person responsible for the animal shall immediately notify the county health department.

Author: William B. Johnston, D.V.M.; Dee Jones, D.V.M.

Statutory Authority: §§3-7A-1, et seq., *Ala. Code 1975*; §22-2-2(6), *Ala. Code 1975*

History: New Rule: Filed September 19, 1997; Effective October 24, 1997; Operative November 4, 1997.

Repeal and Replace: Filed November 19, 2009; Effective December 24, 2009.

420-4-4-.06 Rabies Vaccine Requirements.

(1) Every owner of a dog, cat, or ferret required to be immunized shall cause the animal to be immunized by the rabies officer, his or her authorized representative, or any duly licensed veterinarian, when the animal reaches three months of age and subsequently in accordance with the intervals specified in the rabies vaccine's license.

(2) Notwithstanding paragraph (1) above, in order to assure that the maximum number of animals remain vaccinated for the prevention of rabies in humans and animals, the vaccine interval for rabies vaccines administered in public rabies clinics shall be one year.

Author: William B. Johnston, D.V.M.; Dee Jones, D.V.M.

Statutory Authority: §§3-7A-1, et seq., *Ala. Code 1975* (Alabama Legislature Act 2009-636); §22-2-2(6), *Ala. Code 1975*

History: Repeal and Replace: Filed November 19, 2009; Effective December 24, 2009.

420-4-4-.07 Evidence of Immunization. Evidence of rabies immunization shall be provided to the owner of the animal by the issuance of a certificate and a serially numbered tag.

(a) The information required by §3-7A-2(a), *Ala. Code 1975*, shall be stated on a printed Certificate of Immunization, dated and signed by the person authorized to administer the vaccine. The certificate of immunization shall be provided to the owner of the animal and shall be accompanied by a serially numbered tag bearing the same number and year as that of the certificate.

(b) Certificates of Immunization may be issued on forms provided by the Department. Alternatively, the NASPHV Form 51, which can be obtained from vaccine manufacturers may be used, as well as any computer generated form containing the information required in §3-7A-2(a), *Ala. Code 1975*.

(c) Certificates and records of immunization shall be maintained by the veterinarian for a period of one year past the expiration date on the certificate.

(d) The NASPHV standard tag system shall be used to aid local animal control and public health authorities in identifying the immunization status of animals. The rabies license tags shall follow NASPHV guidelines, distinguishable in shape and color by year of issuance.

Author: William B. Johnston, D.V.M.; Dee Jones, D.V.M.

Statutory Authority: §§3-7A-1, et seq., *Ala. Code 1975*; §22-2-2(6), *Ala. Code 1975*

History: New Rule: Filed September 19, 1997; Effective October 24, 1997; Operative November 4, 1997.

Repeal and Replace: Filed November 19, 2009; Effective December 24, 2009.

420-4-4-.08 Exemptions from Vaccination.

(1) With the written consent of an animal's owner, a veterinarian with a valid client/patient relationship (VC/PR) may issue a certificate exempting an animal from the rabies vaccination requirements in §3-7A-2, *Ala. Code 1975*, if he or she determines that it would be medically contraindicated to vaccinate the animal due to an infirmity, other medical condition, or regimen of therapy. The Certificate of Exemption from Rabies Vaccine form in Appendix A to these rules shall be used.

(2) Certification that the animal is exempt from vaccination shall be valid for a period of one year from the date of the issuance of the certificate of exemption, after which time the animal shall be re-examined by a licensed veterinarian and vaccinated against rabies or a new Certificate of Exemption shall be issued to the animal's owner.

(3) An exempt animal must be vaccinated against rabies as soon as its health permits.

(4) The Certificate of Exemption shall be provided to the animal's owner and a copy shall be provided to the Department within seven days from the date of the issuance of the certificate. The veterinarian who issues the certificate shall maintain a copy of the certificate for a minimum of one year from the date of issuance.

(5) An exemption from the rabies vaccination requirements of these rules does not exempt the animal from other laws and regulations related to animal and rabies control. If the exempted animal is exposed or is suspected of being exposed to rabies (e.g., due to an exposure from a rabid or suspect rabid animal), the Health Officer shall require it to be euthanized or quarantined for six months. If the animal is suspected of exposing a human, it shall be quarantined for 10 days.

Author: William B. Johnston, D.V.M.; Dee Jones, D.V.M.

Statutory Authority: §§3-7A-1, et seq., *Ala. Code 1975* (Alabama Legislature, Act 2009-636); §22-2-2(6), *Ala. Code 1975*

History: New Rule: Filed November 19, 2009; Effective December 24, 2009.

420-4-4-.09 Extra-Label Use of Animal Rabies Vaccines. Extra-label use of rabies vaccines may be considered under the following conditions:

(a) The United States Department of Agriculture regulations and the Food and Drug Administration regulations and guidelines for pharmaceuticals shall be followed relative to the extra-label use of animal rabies vaccines. Notations of extra-label use in domestic animals must also be entered on the animal's veterinary medical record.

(b) Animal rabies vaccines licensed for use in other species may be used in domestic animals when there is a demonstrated need for the product, provided there is evidence that some efficacy can be expected.

(c) Parenteral vaccination of captive native wildlife species shall not be allowed because the period of viral shedding, the clinical syndrome, and the efficacy of vaccines are not established.

(d) Zoos, research institutions, and exotic exhibitors licensed under the United States Department of Agriculture Animal Welfare Act may establish rabies vaccination programs under the supervision of the Department in an attempt to protect valuable animals. These programs should not be in lieu of appropriate quarantine and isolation measures that protect humans.

(e) Due to some uncertainties of the immunologic response to vaccination, the infective period of viral shedding, and the clinical course of disease in hybrid-cross animals, such animals involved in exposures to humans shall be considered for euthanasia on a case-by-case basis by the Department with due consideration given to the species, the circumstances of the exposure, and the epidemiology of rabies in the area.

Author: William B. Johnston, D.V.M.; Dee Jones, D.V.M.

Statutory Authority: §§3-7A-1, et seq., *Ala. Code 1975*; §22-2-2(6), *Ala. Code 1975*

History: New Rule: Filed September 19, 1997; Effective October 24, 1997; Operative November 4, 1997.

Repeal and Replace: Filed November 19, 2009; Effective December 24, 2009.

420-4-4-.10 Adoption of National Compendium. The *Compendium of Animal Rabies Prevention and Control* published in 2008 by the NASPHV and the Centers for Disease Control is hereby adopted by reference and shall serve as a guide for the Department's animal rabies control activities in situations not specifically addressed in the Rules of the State Board of Health. A copy of the *Compendium of Animal Rabies Prevention and Control* may be obtained by contacting the Department's Epidemiological Division of the Bureau of Communicable Diseases at 201 Monroe Street, Suite 1468, Montgomery, Alabama 36130. Standard fees for retrieving and making copies of public records, as referenced in State Board of Health Rule 420-1-5-.04, shall apply.

Author: William B. Johnston, D.V.M.; Dee Jones, D.V.M.

Statutory Authority: §§3-7A-1, et seq., *Ala. Code 1975*; §22-2-2(6), *Ala. Code 1975*

History: New Rule: Filed September 19, 1997; Effective October 24, 1997; Operative November 4, 1997.

Repeal and Replace: Filed November 19, 2009; Effective December 24, 2009.

Alabama Department of Public Health

CERTIFICATE OF EXEMPTION FROM RABIES VACCINE

Name of Owner (Print)		Telephone Number
Street Address	City, State, Zip	
Animal Name	Sex: <input type="checkbox"/> Male <input type="checkbox"/> Female	Neutered: <input type="checkbox"/> Yes <input type="checkbox"/> No
Species	Age	Weight
Breed	Color(s)	
<p>The animal described above has been examined by me on: _____ and I have determined that vaccinating this animal would be medically contraindicated and may cause death due to an infirmity, other physical condition, or regimen of therapy.</p> <p>Describe nature and duration of infirmity, other physical condition, or regimen of therapy:</p> <p>_____</p> <p>_____</p> <p>_____</p> <p>PLEASE NOTE: A reluctance to administer a rabies vaccine prior to the expiration of the previous vaccination will not be accepted as a valid reason for an exemption because it has not been associated with an increased occurrence of adverse reactions and is not medically contraindicated.</p>		

Name of Veterinarian (Print)	License Number	
Address		
Signature of Veterinarian		Date
This Certificate is valid until _____ (not to exceed one year from date signed).		
<p>By signing below, I acknowledge that I am the owner of the animal described above. I have been informed that this animal is exempt from rabies vaccination for a period of up to one year. I have also been informed of the following important information:</p> <ul style="list-style-type: none"> • This animal must be re-examined by the expiration date listed above. At the time the animal must either be vaccinated against rabies or, if exemption status still applies, a new certificate must be issued. • Once the duration of immunity from the last rabies vaccination has lapsed, this animal is not protected against rabies and, as a result, is at increased risk of becoming infected if exposed to a rabid animal. • It is recommended that the animal be closely observed when outside, walked on a leash and not allowed to run at large. Prevent the animal from coming into contact with suspect rabid animals such as raccoons, skunks, foxes, groundhogs, bats and free-roaming cats. • Exemption from rabies vaccination does not exempt the animal from other laws related to rabies. If this animal is exposed or suspected to be exposed to rabies (e.g., due to a bite or exposure from a rabid or suspect rabid animal), the Health Officer will require it to be euthanized or quarantined for six months. If this animal potentially exposes a person to rabies (by bite or other means), it must be quarantined for 10 days and in a manner prescribed by the Health Officer 		
Date Signed		Date

A copy of this certificate must be provided to the owner of the animal listed above and kept as proof of exemption. A copy of this certificate shall be maintained by the veterinarian for a period of one year from the date of issuance.

A copy of this certificate shall be provided to the Department of Public Health within (7) days of issuance.